

TISCH 3 CHANNEL CARBONYL SAMPLER OPERATION MANUAL



February 10, 2008

1. GENERAL DISCUSSION

Aldehydes and ketones belong to a class of compounds called carbonyl compounds. The most common carbonyls in air include formaldehyde, acetaldehyde, and acetone. Carbonyls in air are collected by drawing air through a cartridge impregnated with acidified 2,4-dinitrophenylhydrazine (DNPH), which is very reactive toward carbonyls. The resulting products (hydrazones) in the cartridge are measured in the laboratory using high performance liquid chromatography to determine the levels of the carbonyl compounds originally present in air. Using DRI's standard carbonyl sampler with one channel, a cartridge can be exposed on a predetermined schedule.

Since the reagent is extremely reactive, a cartridge left open will continue to absorb carbonyl compounds from the air until all the reagent is completely consumed. Thus the cartridges are plugged at both ends and placed inside glass screw-capped vials. They are further placed into a tin can for protection during shipment and storage. An open vial, containing DNPH-impregnated material, is placed inside each can to absorb any carbonyls that may intrude into the can to keep the can atmosphere clean. Cartridges are best stored inside a refrigerator.

Cartridges installed in the sampler are protected by a check valve upstream, and a solenoid valve downstream. They are only exposed to the air stream during the period of sampling. When the exposed cartridges are removed, they should be immediately plugged, put into the vials, and stored in a can designated for exposed cartridges. The exposed cartridges should be stored inside a refrigerator and returned to the laboratory in a cooler.

2. APPARATUS, INSTRUMENTATION, REAGENTS, AND FORMS

The sampler consists of flow controller, check valves, solenoid valves and pump. Timers are located in the unit. These samplers are designed to be used indoors or out. A temperature-controlled environment is recommended. Follow the appropriate instructions below for the type of sampler to be installed.

2.1 Apparatus and Instrumentation

The Tisch Environmental 3-channel-event sampling system configuration includes the following primary components (Figure 1):

- **Sample Pump** -- a 120 V.A.C. vacuum pump, capable of drawing air through the cartridges at up to 5 liters per minute. The pump must be free of leaks.

- **Sample Inlet Line** -- chromatographic-grade stainless steel tubing used to connect the sampler to the sample probe, Tisch Ozone Denuder and manifold assembly.

3-CHANNEL CARBONYL SAMPLER
11/13/07

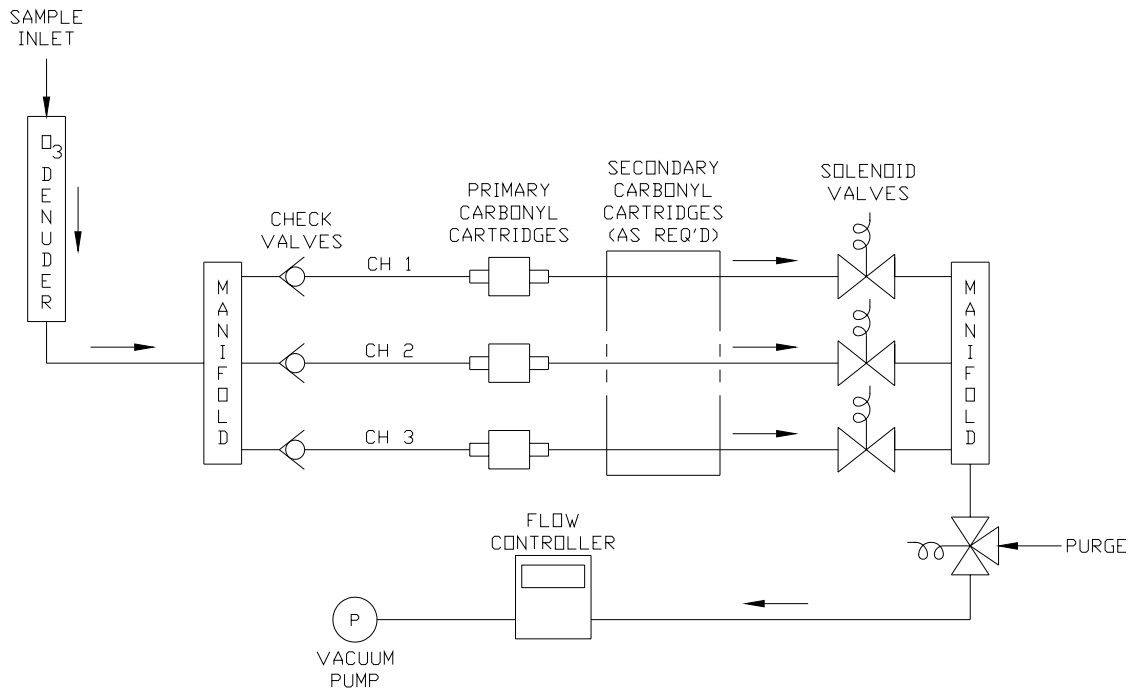

Figure 1. Tisch Aldehyde Sampling System Configuration.

- **Sample Cartridge** -- a DNPH-impregnated cartridge.
- **Adjustable Flow Controller, Valve Solenoid and Manifold** -- The flow can be adjusted by the front panel using the Sierra Instrument manual instruction.
- **Electronic Timer** -- to allow unattended operation (activation and deactivation) of the solenoids in the collection system. The timer is a Touch Screen self prompt seven-day, 3-channel event programmable controller. Instructions are written for each project's special use and placed in the operations book, along with the user's handbook for this timer.
- **Chromatographic-Grade Stainless Steel Tubing and 316 Grade Stainless Steel Fittings** -- used for system interconnections (all tubing in contact with the sample prior to analysis should be chromatographic grade stainless steel and all fittings should be 316 grade stainless steel or Teflon tubing).
- **Total Time Indicator** -- for measuring the duration of the sampling episode. This timer is attached to the vacuum switch and will not count if flow stops for any reason. This is a confirmation of flow in the system.

3. OPERATING PROCEDURES

3.1 Instrument Set-UP

3.1.1 In the sampler, find the following items:

- 3.1.1.1 Teflon sampling line, 1/4-inch O.D. tubing, 20-ft,
- 3.1.1.2 Vacuum pump line, 1/4-inch tubing, 6-ft,
- 3.1.1.3 Power cord for the main unit,
- 3.1.1.4 A filter holder preloaded with charcoal,
- 3.1.1.5 A copy of this SOP, and
- 3.1.1.6 Instructions on how to program and operate the timer.

Title: TISCH Carbonyl Sampler

- 3.1.2 Locate the sampler in the shelter where the stainless steel sampling line can lead to the outside. Strap the line to a pole or similar object to raise the inlet of the line several feet above the roof of the structure.
- 3.1.3 Install the charcoal filter holder in the pump outlet. Remove the plastic plugs and caps from the sampler fittings. Place the plugs and caps into the Zip-loc bag for safe keeping in the pump box. You will need these items when you pack the sampler at the end of the program.
- 3.1.4 Loosen the Teflon nut and insert the sampling line fully into the inlet fitting. Fingertighten the fitting. If the line does not slip from the fitting by a tug on the line, the connection is good. Otherwise, loosen the cap nut slightly, push the line back in, and tighten the fitting until the line is snug. All Teflon and plastic fittings are to be connected in such manner.
- 3.1.5 The timers now should display the current time and day of the week. If there is no display on both timers, either there is no power reaching the unit (a dead AC outlet, bad power cord, or loose connection), or a blown fuse. Unplug the unit before attempting to check the fuse.
- 3.1.6 Uncouple the blank cartridge leading from the manifold outlets for the channel you want to install the sample cartridge. Put the short end of the cartridge into the tube as shown on the front panel diagram and the long end of the cartridge into the other loose tube.
- 3.1.7 In the event of sampling, the cartridge will replace the blank cartridge. The blank cartridge keeps dust from entering the system and contaminating the sample.



SAMPLE COLLECTION

- 3.1.8 Disconnect the clear tubing from the blank cartridge. Leave the blank cartridge in the tray for later use. Connect the long end of a cartridge to the clear tubing line as shown on front panel (vacuum or solenoid valve side). The short end of the cartridge should be connected to the LUER LOCK fitting of the line (inlet or check valve side). A second cartridge can be installed to look for break through from to high of flow for the time of the sampling period.
- 3.1.9 Do not lose the plugs for the cartridge. Place the plug into the vial and leave them on the tray.
- 3.1.10 Verify the correct sample flow rate using the flow controller on the front panel. Step through all cartridges checking flows on each individually channel.
- 3.1.11 Blank sample can be placed on an unused channel.
- 3.1.12 Record on the log sheet, the run times, day of the week, and elapsed time readings onto the sampling field data sheet.
- 3.1.13 Set the electronic timer to begin and stop sampling at the appropriate times.

- 3.1.14 After sample collection, record the run time, day of the week and elapsed time indicator readings. Record any problems in sample collection. Fill in the sampling log sheet (Figure 1). Do not skip any lines. Also record any remarks that you may have, such as power, outages, etc.
- 3.1.15 The information to be recorded includes:
- 3.1.15.1 Site
 - 3.1.15.2 Date the cartridges are installed,
 - 3.1.15.3 Sampling date (presumably the day following installation),
 - 3.1.15.4 Sampler number,
 - 3.1.15.5 Cartridge numbers in each channel,
 - 3.1.15.6 Starting flow rates.
 - 3.1.15.7 Initial reading of the elapsed time indicator and then reset the elapsed timer.
- 3.1.16 When sampling is finished the next day, record the elapsed time indicator reading and the cartridge collection date. The flow rate is checked for each individual cartridge as described above. If the flow rates at the beginning and end of the sampling period differ by more than 15%, the sample should be marked as suspect. Remove the cartridge and plug the ends tightly. Put it into the vial and screw on the cap. Put a label with the site name on the outside of the vial. This will help you to distinguish an exposed cartridge from a new one at a glance. A new cartridge does not have a label on the vial.
- 3.1.17 If sampling continues the following day, install a fresh cartridge and continue sampling as described previously.
- 3.1.18 Put the exposed cartridges into a tin can designated for exposed cartridges. Keep the can in a refrigerator. Samples can be stored under refrigeration and returned to the laboratory on a batch basis, preferably after one or two intensives.
- 3.1.19 Return the can of cartridges, using next-day air in a cooler chilled with blue ice, to the laboratory.

Title: TISCH Carbonyl Sampler

Date: 2/8/08

Revision: 1

ALDEHYDE SAMPLER LOG SHEET

Sampler I.D.: _____ Sample Date: _____

Sample Location: (Site)

Sample Time: Start: _____ Stop: _____

Elapsed Timer: Start: _____
(Hours) (Minutes)

Stop: _____
(Hours) (Minutes)

Lot #: _____ Cartridge #:

Flow Rate:

Before Sampling:

After Sampling:

Comments:

Operators: Start: _____ Stop:

Figure 2. Sampling Log Sheet.

3.1.20 1.3.2 Detailed Procedures

The following provides specific details for operating the 3 Channel Carbonyl samplers.



With the power turn on, the front control panel shows the Tisch logo. The bottom part of the screen will give you the phone number if you need information on the sampler. Touching the **PRESS START TO PROGRAM HERE** area of the screen will take you to the next page.

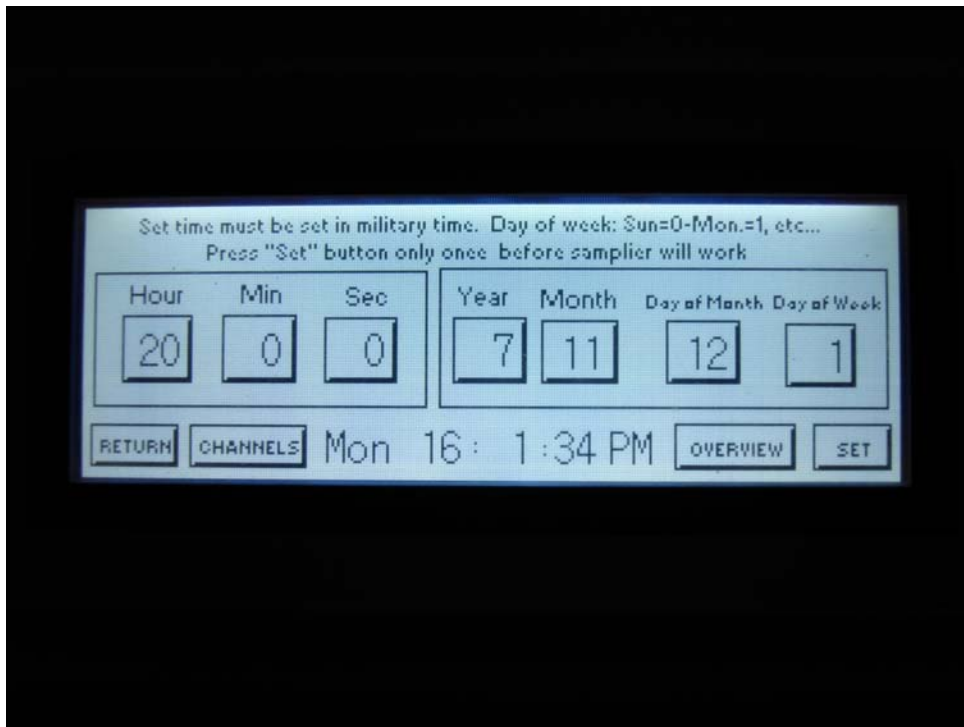

This is where the site **TIME, YEAR, MONTH, DAY, and DAY OF THE WEEK** is installed. The day of the week are, **Sunday=0, Monday=1, Tuesday=2, etc...**

When entering this information, leave your self two extra Minutes of time to finish entering information, then enter when the time is correct. Press Set button only one, if you touch this later on you will put in the original time you installed the first time. This is how the sit time and day of the week is installed, so remember touching this button will change this information.

To set **channels-1 to 3** on times press: **CHANNEL** buttons.

Pressing the **TURN ON PUMP** button will start the pump without the channels on to set the flow. This button is an on/off button, but if left on for 3 minutes the timer in the sampler will turn off the pump. Touching the Set Flow again will start the pump for another 3 minutes.

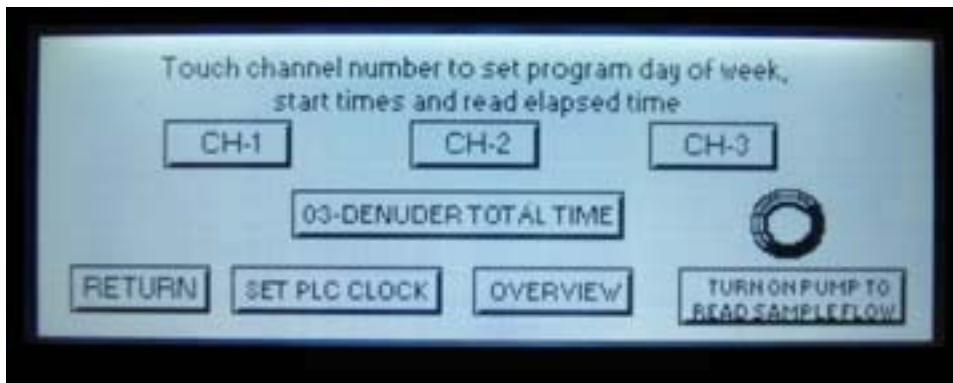

Press **OVERVIEW** button will take you to the overview page. When anything is on or off this page will show you the status of the sampler in the three round lamps and when the pump is on. The set time for each channel is displayed when they are installed.

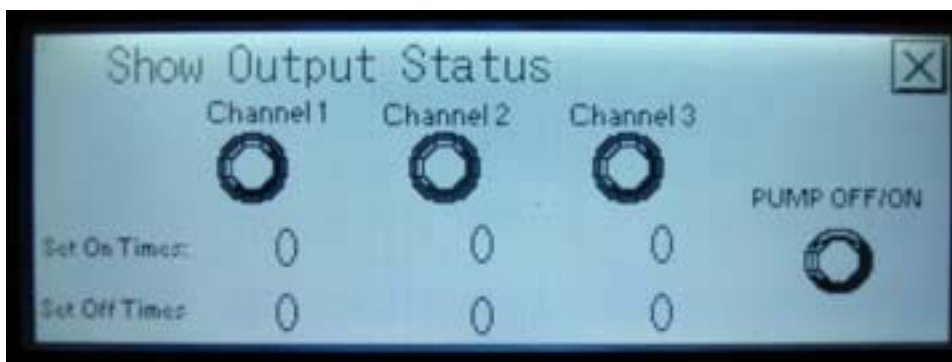

The **CH-1 STATUS** lamp shows when ever the sampler is on or off, with a program or a manual turn on. Also there are lamps on the front of the sample that are mart pump and sampling.

Touch the **SET CHANNEL-1-2-3** button will take you to the channel control page.

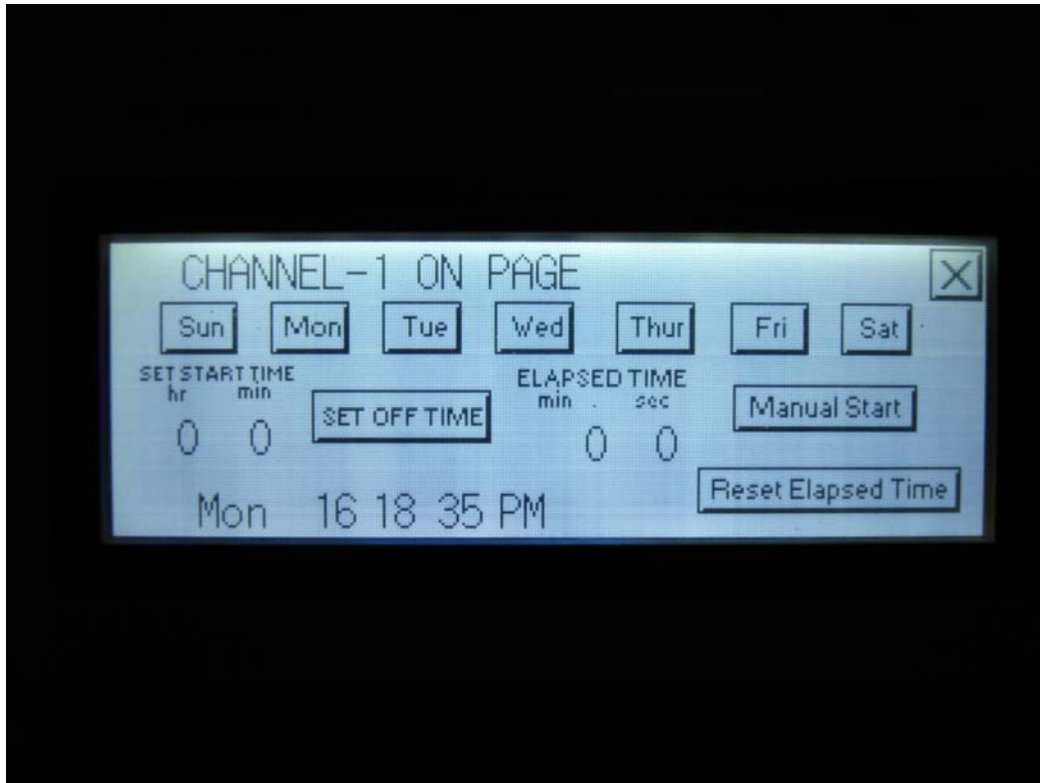

Press the **DAY OF THE WEEK** FOR DAYS THE SAMPLER IS TO RUN.

Press the **Manual Start** to turn on/off sampler for service checks.

Press the **Reset Elapsed** time to clear the timer.

Press the hr. area side of the **SET START TIME** you get this page to enter the on time hr. This will be the same screen shown for the off time. **Remember this is a 24 hour clock** set the hour and minutes if needed, other wise 00 and then touch ENT on the menu. For midnight 12 AM just enter 0 and only minutes until 1:00AM.

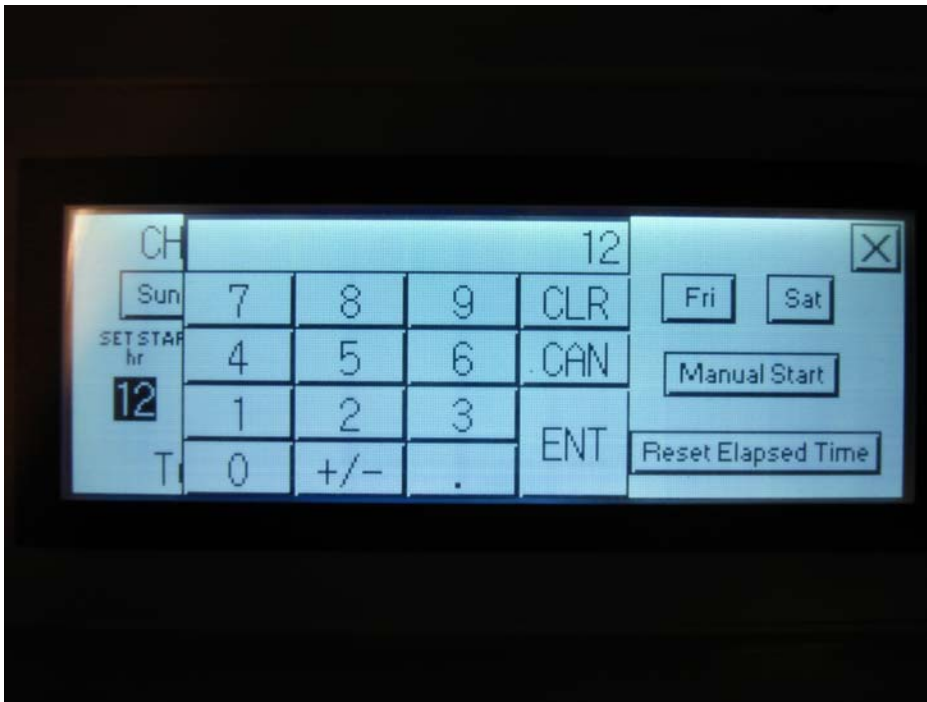

Touch the time you want the sampler to start and touch **ENT** on the menu.

Press the min. area side of the **SET START TIME** you get this page to enter the min. This will be the same screen shown for the off time.

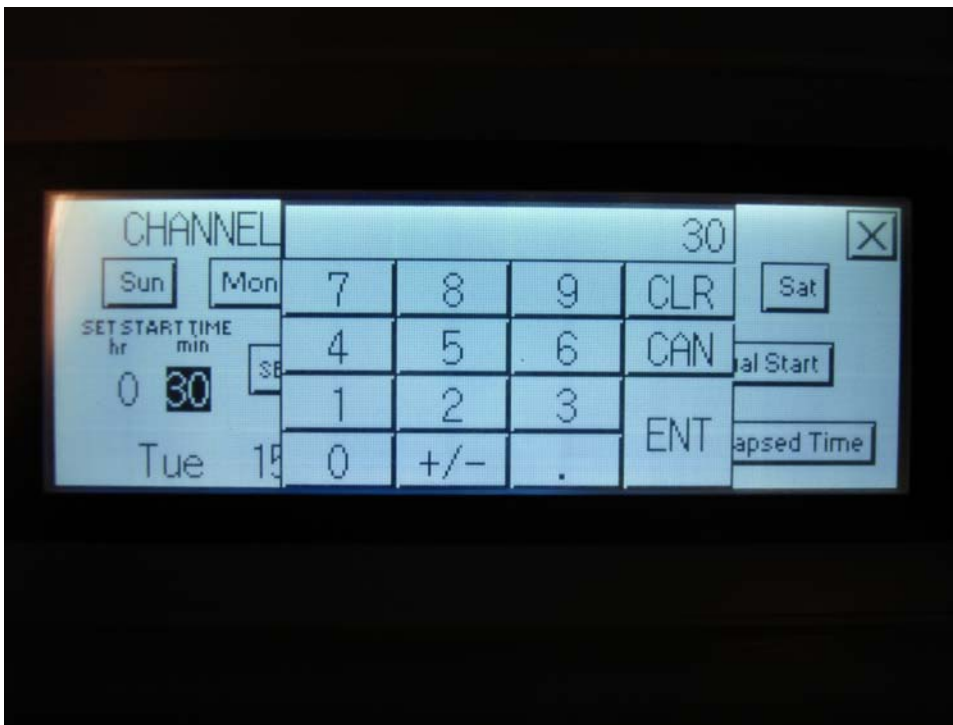

Touch the time you want the sampler to start and touch **ENT** on the menu. If the sampler is to start on an even hour, press 0 and **ENT**.

Press **SET OFF TIME** and you get this screen. Program this page the same way the on page was program.

The **RESET SET ON/OFF TIMES** allows the operator to turn off an on program, without setting an off program to turn of the sampler program. Pressing the button clears the program installed until that time the following week if left in the sampler.

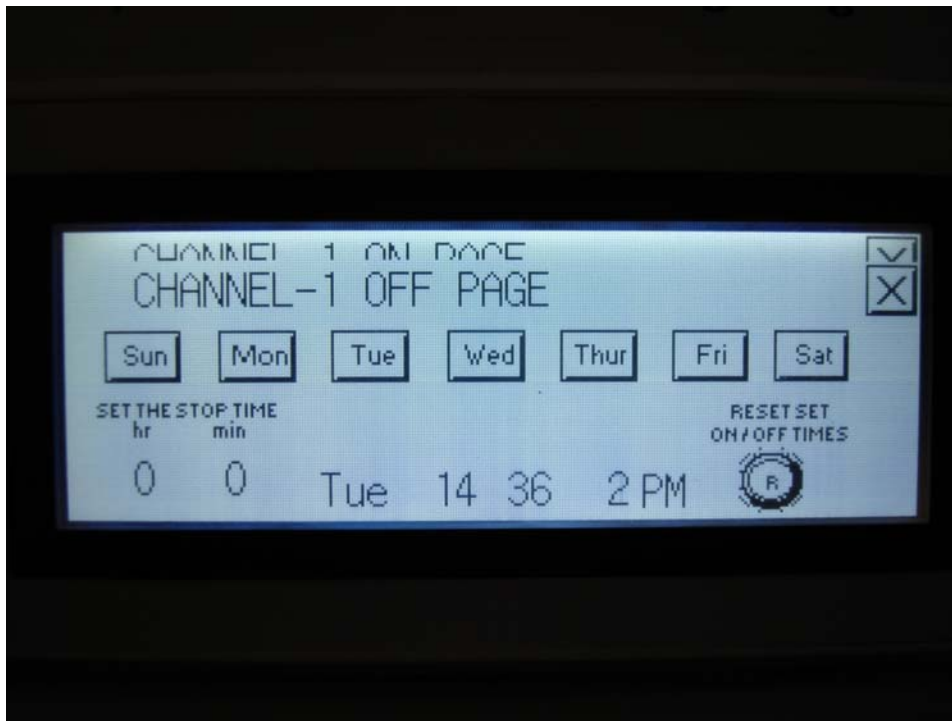

Title: TISCH Carbonyl Sampler

Now with everything entered and check into the touch screens, touch the **X** button in the upper right corner to **EXIT**. This will take you back to the ON program page, check everything is correct. Press the **X** in the upper right corner to **EXIT**. This will take you back to the overview page bellow.

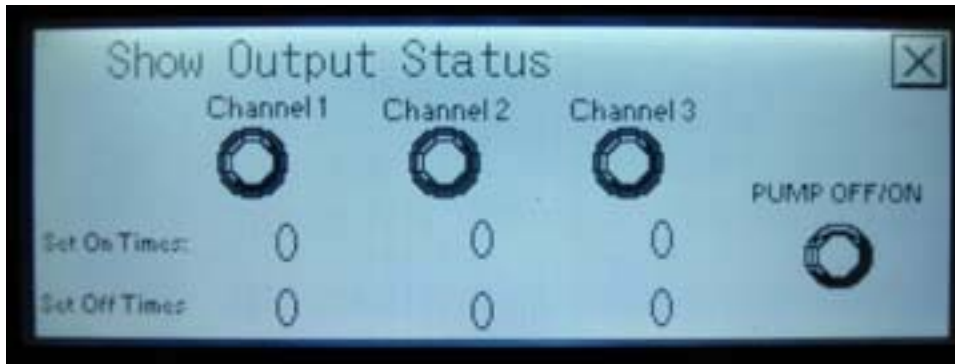

Press **RETURN** and this will take you back to the first program page, as shown bellow.

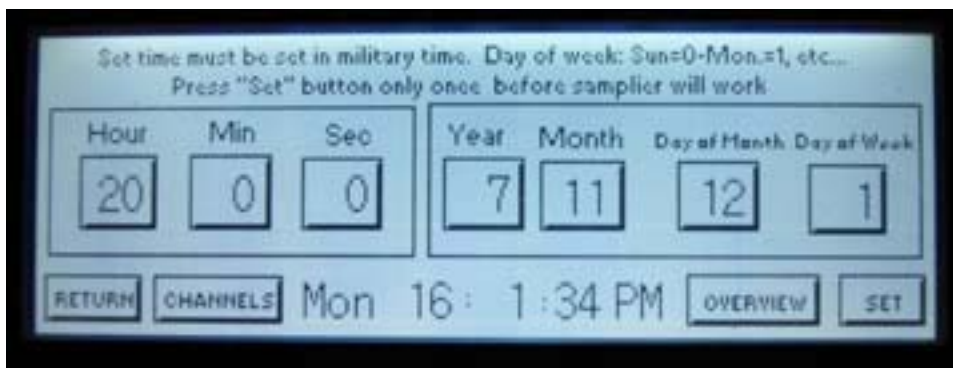

If you are running the sampler on the bench, make sure the inlet filter is installed, to keep dust or dirt from going into the sampler.

NOTE: there is a 3 Minute timer and the pump will go off, or if you touch the set flow button again it will turn off the pump. If you need more time touch set flow button again.

Touch the **Return** button and it will take you back to the Tisch menu.

