



OPERATIONS MANUAL

*TE-5170V-BL Total Suspended Particulate
Volumetric Flow Controller
High Volume Air Sampler*

**Tisch Environmental, Inc.
145 South Miami Avenue
Village of Cleves, Ohio 45002**

Toll Free: (877) 263 -7610 (TSP AND-PM10)

Direct: (513) 467-9000

FAX: (513) 467-9009

sales@tisch-env.com

www.tisch-env.com



TE-5170V-BL TSP VFC

Welcome

We are the experts in high volume air sampling, lead sampling, lead samplers, particulate monitoring, particulate emissions, pesticide monitoring, pesticide sampling, total suspended particles, particulate sampler, Federal Reference Method PM-10, Federal Reference Method PM2.5, EPA Method TO-4A, EPA Method TO-9A, EPA Method TO-13A. TEI is a family business located in the Village of Cleves, Ohio. TEI employs skilled personnel who average over 20 years of experience each in the design, manufacture, and support of air pollution monitoring equipment. Our modern well-equipped factory, quality philosophy and experience have made TEI the supplier of choice for air pollution monitoring equipment. Now working on the fourth generation, TEI has state-of-the-art manufacturing capability and is looking into the future needs of today's environmental professionals.

Assistance

If you encounter problems or require detailed explanations, do not hesitate to contact Tisch Environmental offices by e-mail or phone.

Toll Free: (877) 263 -7610 (TSP AND-PM10)

Direct: (513) 467-9000

FAX: (513) 467-9009

sales@tisch-env.com

www.tisch-env.com

Table of Contents

Introduction	6
EPA Standards	6
Safety Precautions	6
Important Safety Instructions	6
Electrical Installation	7
Do Not Abuse Cords	7
Extension Cords	7
Product Description	8
Introduction	8
Applications	8
Calibration Requirements	9
Calibration Kits	10
Parts	11
Assembly	14
Gabled Roof Assembly	15
Electrical Set-Up	17
Operations	19
Calibration Procedure	19
Example Calculations	25
Sampler Operation	31
Timer Preparation	32
TE-5007 7-Day Mechanical Timer	32
Troubleshooting	33
Maintenance and Care	35
Warranty	36
Assembly Drawings	37
TE-5003V Filter Holder Assembly	37

Calibration Worksheets _____ **38**

Calibration Certificate _____ **40**

Introduction

EPA Standards

The following manual will instruct you in the unpacking, assemblage, operation, calibration, and usage of the corresponding Tisch Environmental product. For information on air sampling principles, procedures and requirements and to ensure compliance with government regulations please contact the local Environmental Protection Agency Office serving your area or visit www.epa.gov.

Safety Precautions

Before using Tisch Environmental products, always be sure to review the corresponding operations manuals and take all necessary safety precautions. Tisch Environmental products are to be used only for the purposes specified by operations manuals and by Tisch Environmental personnel. Tisch Environmental cannot guarantee the safe usage of its instruments in procedures that do not adhere to Tisch Environmental guidelines and standards. If you have concerns about the safety of your product or questions about safe practices, contact Tisch Environmental by phone or e-mail to speak with a representative.

Important Safety Instructions

Read and understand all instructions. Do not dispose of these instructions. Failure to follow all instruction listed in this manual may result in electric shock, fire, and/or personal injury. When using an electrical device, basic precautions must always be followed, including the precautions listed in the safety section of this manual. Never operate this unit in the presence of flammable materials or vapors are present as electrical devices may produce arcs or sparks that can cause fire or explosions. Always disconnect power supply before attempting to service or remove any components. Never immerse electrical parts in water or any other liquid. Always avoid body contact with grounded surfaces when plugging or unplugging this device is wet or dangerous conditions.

Electrical Installation

Installation must be carried out by specialized personal only, and must adhere to all local safety rules. This unit can be used for different power supply versions; before connecting this unit to the power line, always check if the voltage shown on the serial number tag corresponds to the one on your power supply. This product does use grounded plugs and wires. Grounding provides the path of least resistance for electrical currents, thereby reducing the risk of electric shock to users. This system is equipped with electrical cords with internal ground wires and a grounding plug. The plug must be plugged into a matching outlet that is properly installed and grounded in accordance with all local codes and ordinances. Do not modify the plug provided. If plug will not fit outlet, have the proper corresponding outlet installed by a professional, qualified electrician.

Do Not Abuse Cords

In the event that any electrical component of this system needs to be transported, **DO NOT** carry the unit by its power cord or unplug the unit by yanking the cord from the outlet. **Pull the plugs, not the cords**, to reduce risk of damage to unit. Keep all cords away from heat, oil, sharp objects, and moving parts.

Extension Cords

It is always advisable to use the shortest extension cord possible. Grounded units require a three-wire extension cord. As the distance from the supply outlet increases, you must use a heavier gauge extension cord. Using extension cords with inadequately sized wires results in serious changes in voltage, resulting in a loss of power and possible damage to equipment. It is recommended to only use 10-gauge extension cords for this product. Never use cords that exceed one hundred feet. Outdoor extension cords must be marked with the suffix "W-A" (or "W" in Canada) to indicate that it is suitable for outdoor usage. Always ensure that extension cords are properly wired and in good electrical condition. Always replace damaged extension cords immediately, or seek repair from qualified electricians before further use. Remember to protect extension cords from sharp objects, excessive heat, and damp or wet conditions.

Product Description

Introduction

The High Volume Air Sampler (also known as a **lead sampler**) is the recommended instrument for sampling large volumes of air for the collection of TSP (Total Suspended Particulate). The physical design of the sampler is based on aerodynamic principles that result in the collection of particles of 100 microns (Stokes Equivalent Diameter) and less. The TE-5170V-BL TSP VFC sampler consists of a TE-5001 Anodized Aluminum Shelter, TE-5001-10 Gabled Roof Assembly, TE-5070-BL Brushless Blower Motor Assembly, TE-5003V 8"x10" Stainless Steel Filter Holder, TE-5009 Continuous flow/pressure recorder, TE-10557TSP-BL Volumetric Flow Controller, TE-5030 30" Water Manometer, TE-10618 Male Stagnation Fitting, TE-10617 bulkhead fitting, TE-5012 elapsed time indicator, and TE-5007 seven day mechanical timer (system installed with 110volt mains power will also include a step up transformer for the TE-5070-BL blower motor).

Applications

- Ambient air monitoring to determine suspended particulate levels relative to air quality standards.
- Impact of a specific source on ambient levels of suspended particulates by incorporating a "wind-direction-activation" modification which permits the sampler to operate only when conditions are such that a source-receptor relationship exists.
- Monitoring of enclosed environments for relatively high levels of particulate matter, particularly toxic materials.
- Monitoring of emissions from large diameter vents where physical conditions preclude the use of conventional stack-testing equipment.

Calibration Requirements

TE-5170V-BL TSP VFC High Volume Air Sampler should be calibrated:

- Upon installation
- After any motor maintenance
- Once every quarter (three months)
- After 360 sampling hours

Calibration Kits

The TE-5028 is the preferred method to calibrate the TE-5170V-BL VFC TSP High Volume Air Sampler. It simulates change in the resistance by merely rotating the knob on the top of the calibrator. The infinite resolution lets the technician select the desired flow resistance. The TE-5028 calibration kit includes: carrying case, 30" slack tube water manometer, adapter plate, 3' piece of tubing, and TE-5028A orifice with flow calibration certificate. Optional electronic manometer is available.



Each TE-5028A is individually calibrated on a primary standard positive displacement device (Rootsmer) which is directly traceable to NIST.

**** It is recommended by the EPA that each calibrator should be re-calibrated annually. (1998 Code of Federal Regulations Parts 50 to 51, Appendix B to Part 50, Reference Method for the Determination of Suspended Particulate Matter in the Atmosphere, 9.2.17 page 30.)**

Parts

1. Shelter Box - 48" x 20" x 20" 75 lbs

TSP VFC Brushless Sampler System
TE-5170V-BL 110volt, 60hz



Brushless Blower Motor
TE-5070-BL 110volt and 220volt



Volumetric Flow Controller(attached to motor)
TE-10557TSP-BL



Filter Holder
TE-5003V



24 Hour Chart Recorder
TE-5009 110volt, 60hz



Elapsed Time Indicator
TE-5012 110volt, 60hz



7 Day Mechanical Timer
TE-5007 110volt, 60hz



30" Manometer
TE-5030



Male Stagnation Fitting with tubing
TE-10618



Bulkhead Fitting(attached to aluminum
shelter)
TE-10617



Box of Recorder Charts
TE-106



2. Lid Box - 19" x 14" x 14" 9 lbs

Gabled Roof
TE-5001-10



**3. Transformer(only required for 110volt mains power installations)
13" x 13" x 10" 30lbs**

Step Up Transformer(110volts to
220volts)
TE-10965







***** Save the shipping containers and packing material for future use.**



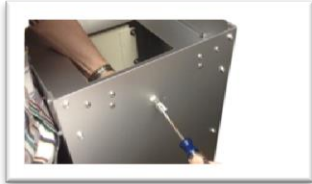

Assembly

1. Open shelter box and remove Anodized Aluminum Shelter, TE-5003V Filter Holder with TE-5005-9 gasket, TE-5030 30" Water Manometer, and TE-5070-BL VFC Brushless Blower Motor Assembly with VFC attached..
2. Open lid box and remove TE-5001-10 Roof (for roof assembly see page 15)
3. Screw TE-5003V Filter Holder onto TE-10557TSP and TE-5070-BL Brushless Blower Motor Assembly make sure TE-5005-9 gasket is in place.
4. Lower Filter Holder, VFC, and Blower Motor down through top support pan on shelter.
5. Connect clear tubing from bulkhead fitting to pressure tap on side of filter holder.
6. Connect black tubing from brushless blower motor to recorder.

Gabled Roof Assembly

The following steps are accompanied by pictures to aid your understanding of gabled roof assembly. **Please be aware that the pictures are standardized and may not match the equipment that you are using.** The gabled roof is used on both TSP and PUF models, and the assembly procedure is the same for both products.

<p><u>Lid Hardware</u> 5 pcs 10-24 x 1/2 pan head screws 5 pcs 10-24 stop nuts 1 pc 6-32 x 3/8 pan head screw 1 pc 6-32 hex nut 1 pc 20" chain with "S" hook 1 pc TE-5001-10-9 roof back catch 1 pc TE-5001-10-10 front catch 1 pc TE-5001-10-11 rear lid hasp</p>	
<p><u>Step 1</u> Secure TE-5001-10-10 front catch to the shelter using 2 10-24 pan head screws with stop nuts. <i>*Do not tighten completely, this may need to be adjusted after final assembly*</i></p>	
<p><u>Step 2</u> Secure TE-5001-10-9 roof back catch to the back of shelter using #6-32 pan head screw with stop nut.</p>	
<p><u>Step 3</u> Secure TE-5001-10-11 rear lid hasp inside the lid with the slot angled up using (2) #10-24 pan head screws with stop nuts. <i>*Do not tighten completely, this may need to be adjusted after final assembly*</i></p>	

<p><u>Step 4</u> Remove (4) #10-24 x ½” pan head screws from the rear of the shelter, attach the lid to the shelter by placing the lid hinge plates on the “OUTSIDE” of the shelter, line the hinges up with the (4) threaded holes in the back of the shelter. Use the (4) #10-24X ½” pan head screws that were removed preciously to attach the lid hinges to the shelter. <i>*Tighten completely*</i></p>	
<p><u>Step 5</u> Adjust the front and rears catch to be sure that the lid slots lowers over it when closing. Tighten the roof back hasp and front catch completely.</p>	 
<p><u>Step 6</u> Attach the chain and “S” hook assembly to the side of the shelter with a #6-32 x 3/8” pan head screw.</p>	
<p><u>Step 7</u> The Lid can now be secured in an open or closed position with the “S” hook.</p>	

Electrical Set-Up

TE-5170V-BL 110volt 60hz Electrical Set-Up

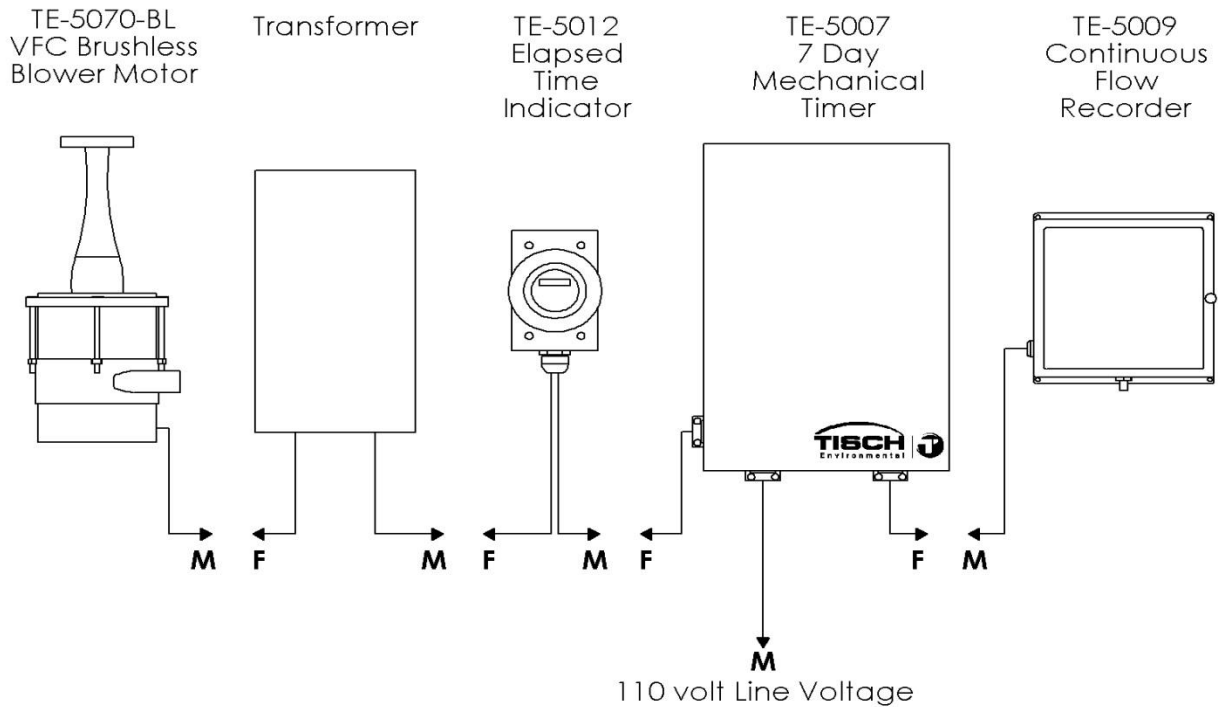

The TE-5070V-BL Brushless Blower Motor male cord set plugs into the Transformer Female cord set.

The Transformer male cord set plugs into the TE-5012 ETI female end.

The male side of TE-5012 ETI plugs into the left timed female of the TE-5007 Mechanical Timer.

The other female cord set on timer (on the right) is hot all the time and plugs into the TE-5009 Continuous Flow Recorder male cord set.

The male cord set of timer plugs into the line voltage

The TE-5070V-BL Brushless Blower Motor male cord set plugs into TE-5012 ETI female end.

The male side of TE-5012 ETI plugs into the left timed female of the TE-5007 Mechanical Timer.

The other female cord set on timer (on the right) is hot all the time and plugs into the TE-5009 Continuous Flow Recorder male cord set.

The male cord set of timer plugs into the line voltage

Operations

Calibration Procedure

The following is a step by step process of the calibration of a TE-5170V Volumetric Flow Controlled TSP Particulate Sampling System. Following these steps are example calculations determining the calibration flow rates for the sampler. The air flow through these types of sampling systems is controlled by a Volumetric Flow Controller (VFC) or dimensional venturi device.

This calibration differs from that of a mass flow controlled TSP sampler in that a slope and intercept does not have to be calculated to determine air flows. Also, the calibrator orifice Q_{actual} slope and intercept from the orifice certification worksheet can be used here, unlike a mass flow controlled TSP where $Q_{standard}$ slope and intercept are used. The flows are converted from actual to standard conditions when the particulate concentrations are calculated. With a Volumetric Flow Controlled (VFC) sampler, the calibration flow rates are provided in a Flow Look Up Table that accompanies each sampler.

The attached example calibration worksheet uses a TE-5028A Variable Orifice Calibrator which uses an adjustable or variable orifice, which we recommend when calibrating a VFC.

Proceed with the following steps to begin the calibration:

Step 1: Mount the calibrator orifice and top loading adapter plate to the sampler. A sampling filter is generally not used during this procedure. Tighten the top loading adapter hold down nuts securely for this procedure to assure that no air leaks are present.

Step 2: Turn on the sampler and allow it to warm up to its normal operating temperature.

Step 3: Conduct a leak test by covering the holes on top of the orifice and pressure tap on the orifice with your hands. Listen for a high-pitched squealing sound made by escaping air. If this sound is heard, a leak is present and the top loading adapter hold-down nuts need to be re-tightened.

Avoid running the sampler for longer than 30 seconds at a time with the orifice blocked. This will reduce the chance of the motor overheating. Also, never try this leak test procedure with a manometer connected to the pressure tap on the calibration orifice or the pressure tap on the side of the sampler. Liquid from either manometer could be drawn into the system and cause motor damage.

Step 4: Connect one side of a water manometer or other type of flow measurement device to the pressure tap on the side of the orifice with a rubber vacuum tube. Leave the opposite side of the manometer open to the atmosphere.

Step 5: Connect a water manometer to the quick disconnect located on the side of the aluminum outdoor shelter (this quick disconnect is connected to the pressure tap on the side of the filter holder).

Step 6: Make sure the TE-5028A orifice is all the way open (turn the black knob counter clock-wise). Record both manometer readings, the one from the orifice and the other from the side of the sampler. To read a manometer one side goes up and the other side goes down, you add both sides, this is your inches of water. Repeat this process for the other four points by adjusting the knob on the variable orifice (just a slight turn) to four different positions and taking four different readings. You should have five sets of numbers, ten numbers in all.

Step 7: Remove the variable orifice and the top loading adapter and install a clean filter. Set your timer.

Step 8: Record the ambient air temperature, the ambient barometric pressure, the sampler serial number, the orifice serial number, the orifice Qactual slope and intercept with date last certified, todays date, site location and the operators initials.

One example calibration sheet and one blank calibration sheet are attached to this manual. To download the electronic spreadsheet, please visit www.tisch-env.com (download the TE-5170V High Vol TSP VFC with G-Factor excel spreadsheet). It is highly recommended to download the electronic excel spreadsheet and use spreadsheet features to complete calculations. (If you do not have a G Factor then go to “TE-5170V High Vol. TSP” excel spreadsheet on web site and then go to page 23)

G-Factor Excel Spreadsheet Instructions

The TE-5170V calibration worksheet can be found on our website at www.tisch-env.com. If you have the G Factor that accompanies each VFC, go to “TE-5170V High Vol. TSP VFC with G-Factor”, if you do not have a G Factor then go to “TE-5170V High Vol. TSP” excel spreadsheet.

Note: Calibration orifices should be sent back to Tisch Environmental for calibration on an annual basis per US EPA Compendium Method IO-2.1 Part 7.3.2 *Sampling of Ambient Air For Total Suspended Particulate Matter (SPM) and PM₁₀ Using High Volume (HV) Sampler*

1. Enter the following information in the corresponding cells in the worksheet:

Site Information

Location	The location of the instrument
Date	Current Date
Tech	Technician performing the calibration
Serial #	Serial number of the instrument, Pxxxx
VFC G Factor	The g-factor of the VFC you are calibrating. This can be found on the lookup table documentation (first page of this doc) or the sticker located on the VFC.

Calibration Orifice Information

Make	The make of the orifice, typically Tisch Environmental
Model	The model number of the orifice, typically TE-5028A
Serial #	The Serial number of the calibration orifice you are using
Qa Slope (m)	The Qa slope of the calibration orifice you are using. This is found on the calibration documentation provided with the calibration orifice
Qa Int (b)	The Qa intercept of the calibration orifice you are using. This is found on the calibration documentation provided with the calibration orifice
Calibration Due Date	The date that the calibration of the orifice is due. Orifices should be calibrated on an annual basis. Call Tisch Environmental at 1-TSP-AND-PM10 to schedule a calibration.

Ambient Conditions

Temp (Deg F)	Enter the current ambient temperature at calibration, Ta in Degrees K and Ta in degrees C will be calculated by the spreadsheet
--------------	---

Barometric Pressure Enter the ambient barometric pressure (Pa) inches of Hg at calibration, the Pa in mmHg will be calculated by the spreadsheet

2. Enter the calibration information by performing each calibration point and entering the following information into each corresponding row for each point:

Calibration Information

Orifice "H ₂ O	The pressure measured at the orifice port using a manometer. The first point should be performed with the orifice knob turned counter-clockwise or wide open, then four consecutive points turning the orifice knob clockwise (not closed) Good idea to take a few extra points here.
Sampler "H ₂ O	The pressure measured at the sampler side port using a manometer (clear tubing that is connect to bulk head fitting that is connected to side of filter holder)

The calibrator flow is calculated (Qa) using the formula:

$$Qa = \frac{1}{Slope} \times \sqrt{"H20x \left(\frac{Ta}{Pa}\right) - Intercept}$$

The calculated flow in m³/min will be calculated using the g-factor formula, this flow will correspond to the flow found in the lookup table supplied with the VFC.

The percent difference will be calculated using the formula:

$$\% \text{ Difference} = \frac{\text{Calculated Flow} - (Qa) \text{ Calibrator Flow}}{(Qa) \text{ Calibrator Flow}} \times 100$$

As per stated in the method IO-2.1, % Difference calculations should be less than +-4%

3. To calculate the total air volume during the sample enter the following information:

Calculate Total Air Volume Using G-Factor

Average	Enter the average temperature of the sample throughout the
---------	--

Temperature	sample period in Deg F. The temperature will then be calculated in Deg K
Barometric Pressure	Enter the average barometric pressure of the sample throughout the sample period in Inches of Hg. The barometric pressure in mmHg will then be calculated
Clean Filter "H ₂ O	Enter the clean filter pressure in inches of water prior to sampling
Dirty Filter "H ₂ O	Enter the dirty filter pressure in inches of water after sampling. The average sample pressure will then be calculated in mmHg
Runtime	Enter the total runtime in hours (xx.xx) of the sample

Using the g-factor formula, Po/Pa will be calculated and an average flow rate of the sample will be calculated in m³/min. Using this information the total sample volume will be calculated.

If you do not have a G Factor, go to TE-5170V High Vol. TSP on web site

An example of a Volumetric Flow Controlled Sampler Calibration Data Sheet has been attached with data filled in from a typical calibration. This includes the transfer standard orifice calibration relationship which was taken from the Orifice Calibration Worksheet that accompanies the calibrator orifice. The slope and intercept are taken from the Qactual section of the Orifice Calibration Worksheet.

The first step is to convert the orifice readings to the amount of actual air flow they represent using the following equation:

$$Q_a = 1/m[\text{Sqrt}((H_2O)(T_a/P_a))-b]$$

where:

Q_a = actual flow rate as indicated by the calibrator orifice, m³/min

H₂O = orifice manometer reading during calibration, in. H₂O

T_a = ambient temperature during calibration, K (K = 273 + °C)

P_a = ambient barometric pressure during calibration, mm Hg

m = slope of Q actual orifice calibration relationship

b = intercept of Q actual orifice calibration relationship.

Once these actual flow rates have been determined for each of the five run points, they are recorded in the column titled Q_a, and are represented in cubic meters per minute. EPA guidelines state that at least three of these calibrator flow rates should be between 1.1 to 1.7 m³/min (39 to 60 CFM). This is the acceptable operating flow rate range of the sampler. If this condition is not met, the sampler should be

recalibrated. An air leak in the calibration system may be the source of this problem. In some cases, a filter may have to be in place during the calibration to meet this condition.

The sampler H₂O readings need to be converted to mm Hg and recorded in the column titled Pf. This is done using the following equation:

$$Pf = 25.4 (\text{in. H}_2\text{O}/13.6)$$

where: Pf is recorded in mm Hg
in. H₂O = sampler side pressure reading during calibration.

Po/Pa is calculated next. This is used to locate the sampler calibration air flows found in the Look Up Table. This is done using the following equation:

$$Po/Pa = 1 - Pf/Pa$$

where: Pa = ambient barometric pressure during calibration, mm Hg.

Using Po/Pa and the ambient temperature during the calibration, consult the Look Up Table to find the actual flow rate. Record these flows in the column titled Look Up.

Calculate the percent difference between the calibrator flow rates and the sampler flow rates using the following equation:

$$\% \text{ Diff.} = (\text{Look Up Flow} - Qa)/Qa * 100$$

where: Look Up Flow = Flow found in Look Up Table, m³/min
Qa = orifice flow during calibration, m³/min.

The EPA guidelines state that the percent difference should be within + or - 3 or 4%. If they are greater than this a leak may have been present during calibration and the sampler should be recalibrated.

Example Calculations

The following example problems use data from the attached VFC sampler calibration worksheet.

After all the sampling site information, calibrator information, and meteorological information have been recorded on the worksheet, actual air flows need to be determined from the orifice manometer readings taken during the calibration using the following equation:

$$1. Q_a = 1/m[\text{Sqrt}((H_2O)(T_a/P_a))-b]$$

where:

2. Q_a = actual flow rate as indicated by the calibrator orifice, m³/min
3. H_2O = orifice manometer reading during calibration, in. H_2O
4. T_a = ambient temperature during calibration, K ($K = 273 + ^\circ C$)
5. P_a = ambient barometric pressure during calibration, mm Hg
6. m = slope of Q actual orifice calibration relationship
7. b = intercept of Q actual orifice calibration relationship.

Note that the ambient temperature is needed in degrees Kelvin to satisfy the Q_a equation. Also, the barometric pressure needs to be reported in millimeters of mercury (if sea level barometric pressure is used it must be corrected to the site elevation). In our case the two following conversions may be needed:

8. degrees Kelvin = $[5/9 (\text{degrees Fahrenheit} - 32)] + 273$
9. millimeters of mercury = $25.4(\text{inches of } H_2O/13.6)$

Inserting the numbers from the calibration worksheet test number one we get:

10. $Q_a = 1/.92408[\text{Sqrt}((3.8)(293/749.3))- (-0.00383)]$
11. $Q_a = 1.0821573[\text{Sqrt}((3.8)(.3910316)) + 0.00383]$
12. $Q_a = 1.0821573[\text{Sqrt}(1.48592) + 0.00383]$
13. $Q_a = 1.0821573[1.2189831 + 0.00383]$
14. $Q_a = 1.0821573[1.2228131]$
15. $Q_a = 1.323$

It is possible that your answers to the above calculations may vary. This is most likely due to different calculators carrying numbers to different decimal points. This should not be an area of concern as generally these variations are slight.

With Q_a determined, the sampler H_2O reading needs to be converted to mm Hg using the following equation:

$$16. P_f = 25.4 (\text{in. } H_2O / 13.6)$$

where:

17. P_f is recorded in mm Hg

18. in. H_2O = sampler side pressure reading during calibration

Inserting the numbers from the worksheet:

$$19. P_f = 25.4(6.4/13.6)$$

$$20. P_f = 25.4(.4705882)$$

$$21. P_f = 11.95294 \text{ mm Hg}$$

P_o/P_a is calculated next. This is done using the following equation:

$$22. P_o/P_a = 1 - P_f/P_a$$

23. where: P_a = ambient barometric pressure during calibration, mm Hg.
Inserting the numbers from the worksheet:

$$24. P_o/P_a = 1 - 11.95294/749.3$$

$$25. P_o/P_a = 1 - .0159521$$

$$26. P_o/P_a = .984$$

Use P_o/P_a and the ambient temperature during the calibration (T_a) to locate the flow for the calibration point in the Look Up table. Record this in the column titled Look Up. Calculate the percent difference using the following equation:

$$27. \% \text{ Difference} = (\text{Look Up flow} - Q_a) / Q_a * 100$$

Inserting the numbers from the worksheet:

$$28. \% \text{ Difference} = (1.287 - 1.323) / 1.323 * 100$$

$$29. \% \text{ Difference} = (-0.036) / 1.323 * 100$$

$$30. \% \text{ Difference} = (-0.0272108) * 100$$

$$31. \% \text{ Difference} = -2.72$$

It is possible that your answers to the above calculations may vary. This is most likely due to different calculators carrying numbers to different decimal points. This should not be an area of concern as generally these variations are slight.

The above calculations have to be performed for all five calibration points. Once this is done, the calibration is complete.

Use of Look-Up-Table to Determine Flow Rate

(NOTE: Individual Look-Up Tables will vary.)

1. Suppose the ambient conditions are:

Temperature: $T_a = 20^\circ\text{C}$

Barometric Pressure: $P_a = 749.3$ mm Hg (this must be station pressure which is not corrected to sea level)

2. Assume system is allowed to warm up for stable operation.

3. Measure filter pressure differential, P_f . This reading is the set-up reading plus pick-up reading divided by 2 for an average reading. This is taken with a differential manometer with one side of the manometer connected to the stagnation tap on the filter holder (or the Bulkhead Fitting) and the other side open to the atmosphere. Filter must be in place during this measurement.

Assume that:

Set-up Reading (clean filter): $P_f = 12.6$ in H_2O

Pick-up Reading (dirty filter): $P_f = 16.0$ in H_2O

$$P_f = (12.6 + 16.0)/2 = 14.3 \text{ in } \text{H}_2\text{O}.$$

4. Convert P_f to same units as barometric pressure.

$$P_f = 14.3 \text{ in } \text{H}_2\text{O} / 13.61 \times 25.4 = 26.687729 \text{ mm Hg}$$

$$P_f = 26.69 \text{ mm Hg}$$

5. Calculate pressure ratio.

$$P_o/P_a = 1 - (P_f/P_a)$$

NOTE: P_f and P_a MUST HAVE CONSISTENT UNITS

$$P_o/P_a = 1 - (26.69 / 749.3)$$

$$P_o/P_a = .964$$

6. Look up Flow Rate from table.

Table 1 is set up with temperature in °C and the Flow Rate is read in units of m³/min (actual, ACMM). In table 2 the temperature is in °F and Flow Rate is read in ft³/min (actual, ACFM).

a) For the example we will use Table 1.

Locate the temperature and pressure ratio entries nearest the conditions of:

$$T_a = 20^\circ\text{C}$$

$$P_o/P_a = .964$$

Example: Look-Up Table for Actual Flow Rate in Units of m³/min

Temperature °C

Po/Pa	20	22	24	26	28
0.961	1.250	1.254	1.258	1.261	1.265
0.962	1.251	1.255	1.259	1.263	1.266
0.963	1.253	1.256	1.260	1.264	1.268
0.964	1.254	1.258	1.262	1.265	1.269
0.965	1.255	1.259	1.263	1.267	1.271
0.966	1.257	1.261	1.264	1.268	1.272

b) The reading of flow rate is:

$$Q_a = 1.254 \text{ m}^3/\text{min (actual)}$$

If your Po/Pa number is not in look up table ie; >.979 then interpolate.

7. Determine flow rate in terms of standard air.

$$Q_{\text{std}} = 1.254 \text{ m}^3 / \text{min} \left(\frac{749.3 \text{ mm Hg}}{760 \text{ mm Hg}} \right) \left(\frac{298 \text{ K}}{(273 + 20) \text{ K}} \right)$$

$$Q_{\text{std}} = 1.257 \text{ std m}^3 / \text{min}$$

The reading of flow rate is:

$$Q_a = 1.260 \text{ m}^3 / \text{min} \text{ (actual)}$$

If your P_o/P_a number is not in look up table ie; $>.979$ then interpolate.

8. Determine flow rate in terms of standard air.

$$Q_{\text{std}} = 1.268 \text{ std m}^3 / \text{min}$$

Sampler Operation

TE-5170V-BL VFC TSP

1. After performing calibration procedure, remove filter holder frame by loosening the four wing nuts allowing the brass bolts and washers to swing down out of the way. Shift frame to one side and remove.
2. Carefully center a new filter, rougher side up, on the supporting screen. Properly align the filter on the screen so that when the frame is in position the gasket will form an airtight seal on the outer edges of the filter.
3. Secure the filter with the frame, brass bolts, and washers with sufficient pressure to avoid air leakage at the edges (make sure that the plastic washers are on top of the frame).
4. Wipe any dirt accumulation from around the filter holder with a clean cloth.
5. Close shelter lid carefully and secure with the "S" hook.
6. Make sure all cords are plugged into their appropriate receptacles and the rubber tubing between the blower motor pressure tap and the TE-5009 continuous flow recorder is connected (be careful not to pinch tubing when closing door).
7. Prepare TE-5009 continuous flow recorder as follows:
 - a. Clean any excess ink and moisture on the inside of recorder by wiping with a clean cloth.
 - b. Depress pen arm lifter to raise pen point and carefully insert a fresh chart.
 - c. Carefully align the tab of the chart to the drive hub of the recorder and press gently with thumb to lower chart center onto hub. Make sure chart is placed under the chart guide clip and the time index clip so it will rotate freely without binding. Set time by rotating the drive hub clock-wise until the correct time on chart is aligned with time index pointer.
 - d. Make sure the TE-160 pen point rests on the chart with sufficient pressure to make a visible trace.

8. Prepare the Timer as instructed below.
9. At the end of the sampling period, remove the frame to expose the filter. Carefully remove the exposed filter from the supporting screen by holding it gently at the ends (not at the corners). Fold the filter lengthwise so that sample touches sample.
10. It is always a good idea to contact the lab you are dealing with to see how they may suggest you collect the filter and any other information that they may need.

Timer Preparation

TE-5007 7-Day Mechanical Timer

1. To set the "START" time, attach a (bright) "ON" tripper to the dial face on the desired "START" time. Tighten tripper screw securely.
2. To set the "STOP" time, attach a (dark) "OFF" tripper to the dial face on the desired "STOP" time. Tighten tripper screw securely.
3. To set current time and day, grasp dial and rotate **clockwise only** until correct time and day appear at time pointer.

Troubleshooting

note: this is a general troubleshooting guide, not all problem may apply to every sampler

<u>Problem</u>	<u>Solution</u>
Brush Motor Won't Turn On	<ul style="list-style-type: none"> -Check Motor brushes(Change every 500 hours) -Check Motor(Should be replaced after 2 brush changes about 1500 hours) -Check power supply -Ensure that all electrical connections are secure -Make sure timer is on -Make sure flow controller(if applicable) is adjusted properly -Check for loose or damaged wires
Brushless Motor Won't Turn On	<ul style="list-style-type: none"> -Ensure that all electrical connections are secure -Make sure flow controller(if applicable) is adjusted properly -Check power supply -Make sure timer is on -Check for loose or damaged wires
Mechanical timer not working	<ul style="list-style-type: none"> -Make sure trippers are set properly -Make sure that trippers are not pressed against switch at start up, the timer need to rotate a few degrees before the trippers hit the switch -Check for loose or damages wires -Check power supply -Check electrical hook up diagram to ensure correct installation -Check Motor
Digital timer not working	<ul style="list-style-type: none"> -Check timer settings -Make sure current date and time are correct -Make sure power cords are properly connected -Check fuse on main PC board (F3) -Check Power Supply -Check Motor
Mass Flow Controller not working	<ul style="list-style-type: none"> -Make sure timer is on -Check Motor/Motor brushes -Make sure 8 amp breaker is not popped -Make sure flow probe is installed correctly -Check all electrical connections -Check power supply

Elapsed Time Indicator not working	<ul style="list-style-type: none"> -Check Power Supply -Check electrical connections
Voltage Variator with ETI not working	<ul style="list-style-type: none"> -Check Power Supply -Check Electrical Connections -Check Motor
Flow Rate Too Low	<ul style="list-style-type: none"> -Check for leaks -Check filter media placement -Ensure only one piece of filter paper is installed -Check Flow Controller -Check flow valve(TE-1000PUF samplers only) -Ensure proper voltage is being supplied -Check calibration
Chart Recorder not working	<ul style="list-style-type: none"> -Replace pen point -Make sure pen point is touching chart -Make sure pen point is on "0" -Make sure tubing from motor is in place -Check Power Supply -Check motor
Air Leaks	<ul style="list-style-type: none"> -Make sure all gaskets are in place -Make sure all connections are secure -Makes sure connections are not over tightened -Check for damaged components: Filter holder screen, gaskets, motor flanges

Maintenance and Care

A regular maintenance schedule will allow a monitoring network to operate for longer periods of time without system failure. Our customers may find that the adjustments in routine maintenance frequencies are necessary due to the operational demands on their sampler(s). We recommend that the following cleaning and maintenance activities be observed until a stable operating history of the sampler has been established.

TE-5170V-BL VFC TSP Sampler

1. Make sure all gaskets (including motor cushion) are in good shape and that they seal properly.
2. The power cords should be checked for good connections and for cracks (replace if necessary).

CAUTION: DO NOT allow power cord or outlets to be immersed in water!

3. Inspect the filter screen and remove any foreign deposits.
4. Inspect the filter holder frame gasket each sample period and make sure of an airtight seal.
5. Make sure elapsed time indicator is working properly.

Warranty

Instruments manufactured by Tisch Environmental, Inc. are guaranteed by warranty to be free of defects in materials and workmanship for one year after shipment from Tisch Environmental factories. The liability of Tisch Environmental, Inc. is limited to servicing or replacing any defective part of any instrument returned to the factory by the original purchaser. All service traceable to defects in original material or workmanship is considered warranty service and is performed free of charge. The expense of warranty shipping charges to and from our factory will be borne by Tisch Environmental. Service performed to rectify an instrument malfunction caused by abuse, acts of god or neglect, and service performed after the one-year warranty period will be charged to the customer at the current prices for labor, parts, and transportation. Brush-type and brushless motors will carry a warranty as far as the original manufacture will pass through its warranty to Tisch Environmental, Inc. The right is reserved to make changes in construction, design specifications, and prices without prior notice.

Assembly Drawings

TE-5003V Filter Holder Assembly

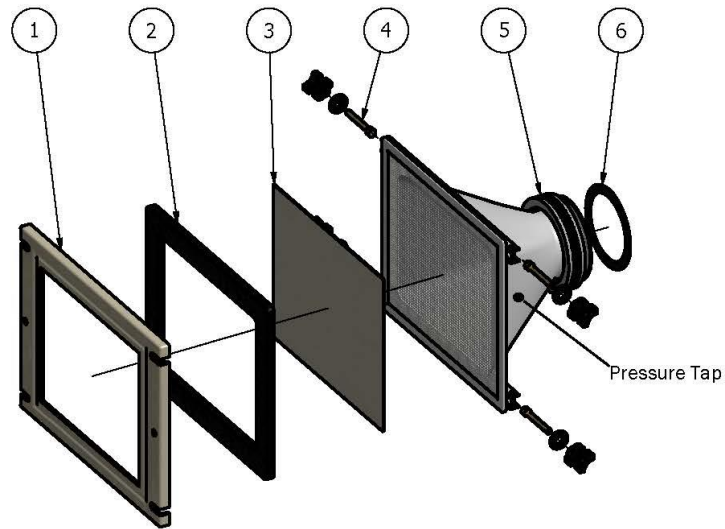

TE-5003V Filter Holder Assembly			
ITEM	QTY	PART NUMBER	DESCRIPTION
1	1	TE-3000-2	Hold Down Frame
2	1	TE-5018	8" x 10" Gasket
3	1	N/A	Filter Paper
4	4	TE-5003-9	Plastic Thumb Nut, Brass Bolt, Washer, and Rivet
5	1	TE-5028-9	Aluminum Threaded Ring
6	1	TE-5005-9	Filter Holder Gasket (Between Filter Holder and Blower Motor)

Calibration Worksheets



TE-5170V Calibration Worksheet

Site Information

Location: Cleves Ohio	Site ID: 145	Date: 31-Oct-14
Sampler: TE-5170V	Serial No: P8644 TSP	Tech: Jim Tisch

Site Conditions

Temp (deg F): 68.0	Barometric Press (in Hg): 29.50
Ta (deg K): 293	Pa (mm Hg): 749
Ta (deg C): 20	

Calibration Orifice

Make: Tisch	Qa Slope: 0.92408
Model: TE-5028A	Qa Intercept: -0.00383
Serial#: 2978.00	Calibration Due Date: 24-Oct-15

Calibration Data

Run Number	Orifice "H2O"	Qa (m3/min)	Sampler "H2O"	Pf (mm Hg)	Po/Pa	Look Up (m3/min)	% Diff
1	3.80	1.323	6.40	11.944	0.984	1.287	-2.72
2	3.80	1.323	6.80	12.691	0.983	1.286	-2.80
3	3.80	1.323	7.20	13.437	0.982	1.284	-2.95
4	3.75	1.315	9.25	17.263	0.977	1.278	-2.81
5	3.75	1.315	10.20	19.036	0.975	1.275	-3.04

Calculations

Calibrator Flow (Qa) = 1/Slope*(SQRT(H20*(Ta/Pa))-Intercept)
 Pressure Ratio (Po/Pa) = 1-Pf/Pa
 % Difference = (Look Up Flow-Calibrator Flow)/Calibrator Flow*100

NOTE: Ensure calibration orifice has been certified within 12 months of use

Tisch Environmental 145 South Miami Ave, Cleves OH 45002 • 877.263.7610 • sales@tisch-env.com • www.tisch-env.com



TE-5170V Sampler Calibration Worksheet (Using G-Factor)

Site and Calibration Information

Site		Calibration Orifice	
Location:	Cleves, OH	Make:	Tisch Environmental
Date:	Oct 31, 2014	Model:	TE-5028A
Tech.:	Jim Tisch	Serial:	1179
Sampler:	TE-5170V	Qa Slope (m):	0.92408
Serial #:	P8644 TSP	Qa Int (b):	-0.00383
VFC G-Factor:	0.0974264900	Calibration due date:	10/24/15

Ambient Conditions

Temp (deg F):	68.0	Barometric Press (in Hg):	29.50
Ta (deg K):	293	Pa (mm Hg):	749.3
Ta (deg C):	20.0		

Calibration Information

Run Number	Orifice "H2O"	Qa m3/min	Sampler "H2O"	Pf mm Hg	Po/Pa	Calculated m3/min	% of Diff
1	3.80	1.323	6.40	11.944	0.984	1.287	-2.72
2	3.80	1.323	6.80	12.691	0.983	1.286	-2.80
3	3.80	1.323	7.20	13.437	0.982	1.284	-2.95
4	3.75	1.315	9.25	17.263	0.977	1.277	-2.81
5	3.75	1.315	10.20	19.036	0.975	1.274	-3.04

Calculate Total Air Volume Using G-Factor

Enter Average Temperature During Sampling Duration (Deg F)	62.00
Average Temperature During Sampling Duration (Deg K)	289.67
Enter Average Barometric Pressure During Sampling Duration (In Hg)	29.40
Average Barometric Pressure During Sampling (mm Hg)	746.76
Enter Clean Filter Sampler Inches of Water	12.60
Enter Dirty Filter Sampler Inches of Water	16.00
Average Filter Sampler (mm Hg)	26.69
Enter Total Runtime in Hours (xx.xx)	23.90
	Po/Pa : 0.964
	Calculated Flow Rate (m3/min): 1.254
	Total Flow (m3): 1797.57

Calculations

$$\text{Calibrator Flow (Qa)} = 1/\text{Slope} * (\text{SQRT}(\text{H2O} * (\text{Ta}/\text{Pa})) - \text{Intercept})$$

$$\text{Pressure Ratio (Po/Pa)} = 1 - \text{Pf}/\text{Pa}$$

$$\% \text{ Difference} = (\text{Look Up Flow} - \text{Calibrator Flow}) / \text{Calibrator Flow} * 100$$

NOTE: Ensure calibration orifice has been certified within 12 months of use

Tisch Environmental 145 South Miami Ave, Cleves OH 45002 • 877.263.7610 • sales@tisch-env.com • www.tisch-env.com

Calibration Certificate



TISCH ENVIRONMENTAL, INC.
 145 SOUTH MIAMI AVE
 VILLAGE OF CLEVELS, OH
 45002
 513.467.9000
 877.263.7610 TOLL FREE
 513.467.9009 FAX

ORIFICE TRANSFER STANDARD CERTIFICATION WORKSHEET TE-5028A

Date - Oct 24, 2014 Rootmeter S/N 9833620 Ta (K) - 296
 Operator Tisch Orifice I.D. - 2978 Pa (mm) - 755.65

PLATE OR VDC #	VOLUME START (m3)	VOLUME STOP (m3)	DIFF VOLUME (m3)	DIFF TIME (min)	METER DIFF Hg (mm)	ORFICE DIFF H2O (in.)
1	NA	NA	1.00	1.1880	4.5	1.50
2	NA	NA	1.00	0.9230	7.5	2.50
3	NA	NA	1.00	0.8380	9.0	3.00
4	NA	NA	1.00	0.7790	10.5	3.50
5	NA	NA	1.00	0.5860	18.0	6.00

DATA TABULATION

Vstd	(x axis) Qstd	(y axis)	Va	(x axis) Qa	(y axis)
0.9950	0.8375	1.2254	0.9940	0.8367	0.7665
0.9910	1.0737	1.5819	0.9901	1.0727	0.9896
0.9891	1.1803	1.7329	0.9881	1.1791	1.0840
0.9871	1.2671	1.8718	0.9861	1.2659	1.1709
0.9771	1.6674	2.4507	0.9761	1.6657	1.5331
Qstd slope (m) = 1.47574			Qa slope (m) = 0.92408		
intercept (b) = -0.00613			intercept (b) = -0.00383		
coefficient (r) = 0.99985			coefficient (r) = 0.99985		
y axis = SQRT [H2O (Pa/760) (298/Ta)]			y axis = SQRT [H2O (Ta/Pa)]		

CALCULATIONS

$$Vstd = \text{Diff. Vol} [(Pa - \text{Diff. Hg}) / 760] (298 / Ta)$$

$$Qstd = Vstd / \text{Time}$$

$$Va = \text{Diff Vol} [(Pa - \text{Diff Hg}) / Pa]$$

$$Qa = Va / \text{Time}$$

For subsequent flow rate calculations:

$$Qstd = 1/m \{ [\text{SQRT} (H2O (Pa/760) (298/Ta))] - b \}$$

$$Qa = 1/m \{ [\text{SQRT} H2O (Ta/Pa)] - b \}$$