



OPERATIONS MANUAL

*TE-5000D Total Suspended Particulate
High Volume Air Sampler
With Digital Timer*

**Tisch Environmental, Inc.
145 South Miami Avenue
Village of Cleves, Ohio 45002**

Toll Free: (877) 263 -7610 (TSP AND-PM10)

Direct: (513) 467-9000

FAX: (513) 467-9009

sales@tisch-env.com

www.tisch-env.com



TE-5000-D TSP

Welcome

We are the experts in high volume air sampling, lead sampling, lead samplers, particulate monitoring, particulate emissions, pesticide monitoring, pesticide sampling, total suspended particles, particulate sampler, Federal Reference Method PM-10, Federal Reference Method PM2.5, EPA Method TO-4A, EPA Method TO-9A, EPA Method TO-13A. TEI is a family business located in the Village of Cleves, Ohio. TEI employs skilled personnel who average over 20 years of experience each in the design, manufacture, and support of air pollution monitoring equipment. Our modern well-equipped factory, quality philosophy and experience have made TEI the supplier of choice for air pollution monitoring equipment. Now working on the fourth generation, TEI has state-of-the-art manufacturing capability and is looking into the future needs of today's environmental professionals.

Assistance

If you encounter problems or require detailed explanations, do not hesitate to contact Tisch Environmental offices by e-mail or phone.

Toll Free: (877) 263 -7610 (TSP AND-PM10)

Direct: (513) 467-9000

FAX: (513) 467-9009

sales@tisch-env.com

www.tisch-env.com

Table of Contents

Welcome _____	3
Assistance _____	3
Introduction _____	6
EPA Standards _____	6
Safety Precautions _____	6
Important Safety Instructions _____	6
Electrical Installation _____	7
Do Not Abuse Cords _____	7
Extension Cords _____	7
Product Description _____	8
Introduction _____	8
Applications _____	8
Calibration Requirements _____	8
Calibration Kits _____	9
Parts _____	10
Assembly _____	12
Gabled Roof Assembly _____	13
Electrical Set-Up _____	15
Operations _____	16
Calibration Procedure _____	16
Example Problems _____	19
Total Volume _____	25
Sampler Operation _____	26
Timer Preparation _____	28
Troubleshooting _____	30
Maintenance and Care _____	32
Motor Brush Replacement _____	33
Warranty _____	36

<i>Assembly Drawings</i> _____	37
TE-5005 Blower Motor Assembly _____	37
TE-5003 Filter Holder Assembly _____	38
<i>Calibration Worksheet</i> _____	39
<i>Calibrator Certificate</i> _____	40

Introduction

EPA Standards

The following manual will instruct you in the unpacking, assemblage, operation, calibration, and usage of the corresponding Tisch Environmental product. For information on air sampling principles, procedures and requirements and to ensure compliance with government regulations please contact the local Environmental Protection Agency Office serving your area or visit www.epa.gov.

Safety Precautions

Before using Tisch Environmental products, always be sure to review the corresponding operations manuals and take all necessary safety precautions. Tisch Environmental products are to be used only for the purposes specified by operations manuals and by Tisch Environmental personnel. Tisch Environmental cannot guarantee the safe usage of its instruments in procedures that do not adhere to Tisch Environmental guidelines and standards. If you have concerns about the safety of your product or questions about safe practices, contact Tisch Environmental by phone or e-mail to speak with a representative.

Important Safety Instructions

Read and understand all instructions. Do not dispose of these instructions. Failure to follow all instruction listed in this manual may result in electric shock, fire, and/or personal injury. When using an electrical device, basic precautions must always be followed, including the precautions listed in the safety section of this manual. Never operate this unit in the presence of flammable materials or vapors are present as electrical devices may produce arcs or sparks that can cause fire or explosions. Always disconnect power supply before attempting to service or remove any components. Never immerse electrical parts in water or any other liquid. Always avoid body contact with grounded surfaces when plugging or unplugging this device is wet or dangerous conditions.

Electrical Installation

Installation must be carried out by specialized personal only, and must adhere to all local safety rules. This unit can be used for different power supply versions; before connecting this unit to the power line, always check if the voltage shown on the serial number tag corresponds to the one on your power supply. This product does use grounded plugs and wires. Grounding provides the path of least resistance for electrical currents, thereby reducing the risk of electric shock to users. This system is equipped with electrical cords with internal ground wires and a grounding plug. The plug must be plugged into a matching outlet that is properly installed and grounded in accordance with all local codes and ordinances. Do not modify the plug provided. If plug will not fit outlet, have the proper corresponding outlet installed by a professional, qualified electrician.

Do Not Abuse Cords

In the event that any electrical component of this system needs to be transported, **DO NOT** carry the unit by its power cord or unplug the unit by yanking the cord from the outlet. **Pull the plugs, not the cords**, to reduce risk of damage to unit. Keep all cords away from heat, oil, sharp objects, and moving parts.

Extension Cords

It is always advisable to use the shortest extension cord possible. Grounded units require a three-wire extension cord. As the distance from the supply outlet increases, you must use a heavier gauge extension cord. Using extension cords with inadequately sized wires results in serious changes in voltage, resulting in a loss of power and possible damage to equipment. It is recommended to only use 10-gauge extension cords for this product. Never use cords that exceed one hundred feet. Outdoor extension cords must be marked with the suffix "W-A" (or "W" in Canada) to indicate that it is suitable for outdoor usage. Always ensure that extension cords are properly wired and in good electrical condition. Always replace damaged extension cords immediately, or seek repair from qualified electricians before further use. Remember to protect extension cords from sharp objects, excessive heat, and damp or wet conditions.

Product Description

Introduction

The High Volume Air Sampler (also known as a **lead sampler**) is the recommended instrument for sampling large volumes of air for the collection of TSP (Total Suspended Particulate). The physical design of the sampler is based on aerodynamic principles that result in the collection of particles of 100 microns (Stokes Equivalent Diameter) and less. The TE-5000-D TSP sampler consists of a TE-5001 Anodized Aluminum Shelter, TE-5001-10 Gabled Roof Assembly, TE-5005 Aluminum Blower Motor Assembly, TE-5003 8"x10" Stainless Steel Filter Holder, TE-5009 Continuous flow/pressure recorder, TE-106 Box of Charts, TE-5010 Voltage Variator, and TE-303 Digital Timer/Elapsed Time Indicator.

Applications

- Ambient air monitoring to determine suspended particulate levels relative to air quality standards.
- Impact of a specific source on ambient levels of suspended particulates by incorporating a "wind-direction-activation" modification which permits the sampler to operate only when conditions are such that a source-receptor relationship exists.
- Monitoring of enclosed environments for relatively high levels of particulate matter, particularly toxic materials.
- Monitoring of emissions from large diameter vents where physical conditions preclude the use of conventional stack-testing equipment.

Calibration Requirements

TE-5000-D TSP High Volume Air Sampler should be calibrated:

- Upon installation
- After any motor maintenance
- Once every quarter (three months)
- After 360 sampling hours

Calibration Kits

The TE-5028 is the latest calibration kit available for use with the TE-5000-D TSP MFC High Volume Air Sampler.

The TE-5028 is the preferred method to calibrate the TE-5000-D MFC TSP High Volume Air Sampler. It simulates change in the resistance by merely rotating the knob on the top of the calibrator. The infinite resolution lets the technician select the desired flow resistance. The TE-5028 calibration kit includes: carrying case, 30" slack tube water manometer, adapter plate, 3' piece of tubing, and TE-5028A orifice with flow calibration certificate. Optional electronic manometer is available.



Each TE-5028A is individually calibrated on a primary standard positive displacement device (Rootsmeter) which is directly traceable to NIST.

**** It is recommended by the EPA that each calibrator should be re-calibrated annually for accuracy and reliability.**

Parts

1. Shelter Box – 48” x 20” x 20”, 72lbs

TSP Air Sampler

TE-5000D 110volt, 60hz

TE-5000DX 220volt, 50hz

TE-5000DXZ 220volt, 60hz



Digital Timer

TE-303 110volt

TE-303X 220volt



Continuous Flow Recorder

TE-5009 110volt, 60hz

TE-5009X 220volt, 50hz

TE-5009XZ 220volt, 60hz



Motor Voltage Control

TE-5010 110volt, 60hz

TE-5010X 220volt, 50hz

TE-5010XZ 20volt, 60hz



Blower Motor Assembly with Tubing

TE-5005 110volt

TE-5005X 220volt



8" x 10" TSP Stainless Steel
Filter Holder
TE-5003



Filter Holder Gasket
TE-5005-9

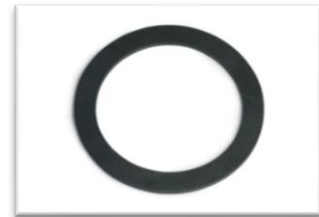

Envelope box of charts and manual
TE-106



2. Lid Box - 19" x 14" x 14" 9 lbs

Gabled Roof
TE-5001-10







*** Save the shipping containers and packing material for future use.



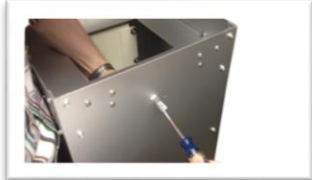

Assembly

1. Open shelter box and remove Anodized Aluminum Shelter.
2. Enclosed in the 13" x 10" x 9" box on bottom of shelter is the TE-5005 Blower Motor Assembly. Enclosed in the 13" x 10" x 9" box inside of shelter is the TE-5003 Filter Holder with TE-5005-9 gasket. Remove from boxes.
3. Screw TE-5005 Filter Holder onto TE-5005 Blower Motor Assembly (tubing and power cord to the right) make sure TE-5005-9 gasket is in place.
4. Lower Filter Holder and Blower Motor down through top support pan in shelter. Connect tubing from pressure tap of blower motor to TE-5009 Flow Recorder.
5. Open lid box and remove 5001-10 Roof.

Gabled Roof Assembly

The following steps are accompanied by pictures to aid your understanding of gabled roof assembly. **Please be aware that the pictures are standardized and may not match the equipment that you are using.** The gabled roof is used on both TSP and PUF models, and the assembly procedure is the same for both products.

<p><u>Lid Hardware</u> 5 pcs 10-24 x 1/2 pan head screws 5 pcs 10-24 stop nuts 1 pc 6-32 x 3/8 pan head screw 1 pc 6-32 hex nut 1 pc 20" chain with "S" hook 1 pc TE-5001-10-9 roof back catch 1 pc TE-5001-10-10 front catch 1 pc TE-5001-10-11 rear lid hasp</p>	
<p><u>Step 1</u> Secure TE-5001-10-10 front catch to the shelter using 2 10-24 pan head screws with stop nuts. <i>*Do not tighten completely, this may need to be adjusted after final assembly*</i></p>	
<p><u>Step 2</u> Secure TE-5001-10-9 roof back catch to the back of shelter using #6-32 pan head screw with stop nut.</p>	
<p><u>Step 3</u> Secure TE-5001-10-11 rear lid hasp inside the lid with the slot angled up using (2) #10-24 pan head screws with stop nuts. <i>*Do not tighten completely, this may need to be adjusted after final assembly*</i></p>	

<p><u>Step 4</u> Remove (4) #10-24 x ½” pan head screws from the rear of the shelter, attach the lid to the shelter by placing the lid hinge plates on the “OUTSIDE” of the shelter, line the hinges up with the (4) threaded holes in the back of the shelter. Use the (4) #10-24X ½” pan head screws that were removed preciously to attach the lid hinges to the shelter. <i>*Tighten completely*</i></p>	
<p><u>Step 5</u> Adjust the front and rears catch to be sure that the lid slots lowers over it when closing. Tighten the roof back hasp and front catch completely.</p>	 
<p><u>Step 6</u> Attach the chain and “S” hook assembly to the side of the shelter with a #6-32 x 3/8” pan head screw.</p>	
<p><u>Step 7</u> The Lid can now be secured in an open or closed position with the “S” hook.</p>	

Electrical Set-Up

TE-5000-D Electrical Set-Up

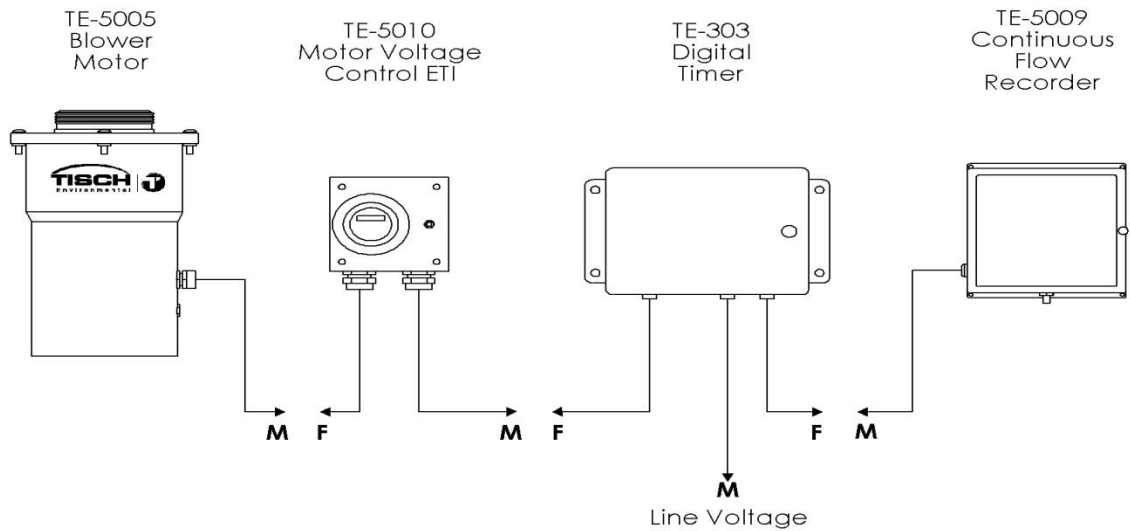

The TE-5005 Blower Motor male cord set plugs into the TE-5010 Motor Voltage Control Female cord set.

The male cord set of the Motor Voltage Control plugs into the TE-5007 7-Day Mechanical Timer timed female cord set which is on the left side of timer.

The other female cord set on timer (on the right) is hot all the time and plugs into the TE-5009 Continuous Flow Recorder male cord set.

The male cord set of timer plugs into the line voltage.

Operations

Calibration Procedure

Visit, www-tisch-env.com, to download calibration worksheets. The calibration worksheets allow the user to input the data and automatically make the calculations. The manual calculation method is described in the following sections for your reference, however, it is highly recommended to download the calibration worksheets.

Proceed with the following steps to begin the calibration:

1. Disconnect the sampler motor from the variac (TE-5010) and connect the motor to a stable AC power source.
2. Mount the top loading adapter plate (TE-5035) on top of filter holder and tighten the hold down nuts securely to assure that no air leaks are present. Screw the calibration orifice (make sure the TE-5028A is wide open by turning black knob counter-clockwise) on to the top loading adapter plate. A sampling filter is generally not used during this procedure.
3. Allow the sampler motor to warm up to its normal operating temperature.
4. Conduct a leak test by covering the holes on top of the orifice and pressure tap. Listen for a high-pitched squealing sound made by escaping air. If this sound is heard, a leak is present and the top loading adapter hold-down nuts need to be re-tightened.

Avoid running the sampler for longer than 30 seconds at a time with the orifice blocked. This will reduce the chance of the motor overheating. Also, never try this leak test procedure with a manometer connected to the side tap on the calibration orifice. Liquid from the manometer could be drawn into the system and cause motor damage.

5. Connect one side of a water manometer or other type of flow measurement device to the pressure tap on the side of the orifice with a rubber vacuum tube. Leave the opposite side of the manometer open to the atmosphere.

6. Record the manometer reading from the orifice and the continuous flow recorder reading from the sampler (if pen on recorder is off of chart, turn knob on calibrator to get pen on chart for a readable number). A manometer must be held vertically to insure accurate readings (one side of the manometer goes up and one goes down, add both sides this is your H₂O (in)). Tapping the backside of the continuous flow recorder will help to center the pen and give accurate readings. Repeat this procedure by turning the orifice (TE-5028A) knob a little bit (this will cause more resistance) and taking the manometer and continuous flow recorder readings. Do this until you have 5 sets of readings. Sometimes it is wise to take a few extra readings in case there is a problem with some of the them. If you are using a fixed orifice (TE-5025A), five flow rates are achieved in this step by changing the different plates to change the resistance.
7. Record the ambient air temperature, the ambient barometric pressure, the sampler serial number, the orifice s/n, the orifice Q_{standard} slope and intercept with date last certified, todays date, site location and the operators initials.
8. Disconnect the sampler motor from its power source and remove the orifice and top loading adapter plate. Re-connect the sampler motor to the variac (TE-5010).

An example of a Lead (or TSP) Sampler Calibration Data Sheet has been attached with data filled in from a typical calibration. This includes the transfer standard orifice calibration relationship which was taken from the Orifice Calibration Worksheet that accompanies the calibrator orifice. Since this calibration is for a TSP sampler, the slope and intercept for this orifice uses **standard** flows rather than actual flows and is taken from the Q_{standard} section of the Orifice Calibration Worksheet. The Q_{actual} flows are used when calibrating a PM-10 sampler.

The five orifice manometer readings taken during the calibration have been recorded in the column on the data worksheet titled H₂O (in). The five continuous flow recorder readings taken during the calibration have been recorded under the column titled I chart.

The orifice manometer readings need to be converted to the standard air flows they represent using the following equation:

$$Q_{std} = 1/m[(\text{Sqrt}((H_2O)(Pa/760)(298/T_a)))-b]$$

where:

Qstd = actual flow rate as indicated by the calibration orifice, m³/min

H₂O = orifice manometer reading during calibration, in. H₂O

T_a = ambient temperature during calibration, K (K = 273 + °C)

298 = standard temperature, a constant that never changes, K

P_a = ambient barometric pressure during calibration, mm Hg

760 = standard barometric pressure, a constant that never changes, mm Hg

m = *Q* standard slope of orifice calibration relationship

b = *Q* standard intercept of orifice calibration relationship

Once these standard flow rates have been determined for each of the five run points, they are recorded in the column titled Qstd, and are represented in cubic meters per minute.

The continuous flow recorder readings taken during the calibration need to be corrected to the current meteorological conditions using the following equation:

$$IC = I[\text{Sqrt}((P_a/760)(298/T_a))]$$

where:

IC = continuous flow recorder readings corrected to current T_a and P_a

I = continuous flow recorder readings during calibration

P_a = ambient barometric pressure during calibration, mm Hg.

760 = standard barometric pressure, a constant that never changes, mm Hg

T_a = ambient temperature during calibration, K (K = 273 + °C)

298 = standard temperature, a constant that never changes, K

After each of the continuous flow recorder readings have been corrected, they are recorded in the column titled IC corrected.

Using Qstd and IC as the x and y axis respectively, a slope, intercept, and correlation coefficient can be calculated using the least squares regression method. The correlation coefficient should never be less than 0.990 after a five point calibration. A coefficient below .990 indicates a calibration that is not linear and the calibration should be performed again. If this occurs, it is most likely the result of an air leak during the calibration.

The equations for determining the slope (m) and intercept (b) are as follows:

$$m = \frac{\frac{(\sum x)(\sum y)}{n} - \frac{\sum xy}{n}}{\frac{(\sum x)^2}{n} - \frac{\sum x^2}{n}} ; b = \bar{y} - m\bar{x}$$

where:

n = number of observations

y = $\sum y/n$; x = $\sum x/n$

Σ = sum of

The equation for the coefficient of correlation (r) is as follows:

$$r = \frac{\frac{(\sum x)(\sum y)}{n} - \frac{\sum xy}{n}}{\sqrt{\left[\frac{\sum x^2}{n} - \frac{(\sum x)^2}{n} \right] \left[\frac{\sum y^2}{n} - \frac{(\sum y)^2}{n} \right]}}$$

where:

n = number of observations

Σ = sum of

The acceptable operating flow range of a TSP sampler is 1.1 to 1.7 m³/min (39 to 60 CFM). Looking at the worksheet column Qstd, the flow rates that are within this range can be identified along with the chart reading that represents them. For instance if you wanted to set this sampler at 1.451 m³/min (51.24 CFM) (Make sure the variac (TE-5010) is plugged in and a filter is in place) you would turn the shaft lock on the variac (TE-5010) until the continuous flow recorder read 57 on the chart. By making sure that the sampler is operating at a chart reading that is within the acceptable range, it can be assumed that valid TSP data is being collected.

Example Problems

The following example problems use data from the attached calibration worksheet.

After all the sampling site information, calibrator information, and meteorological information have been recorded on the worksheet, standard air flows need to be determined from the orifice manometer readings taken during the calibration using the following equation:

$$1. \quad Q_{std} = 1/m[(\text{Sqrt}((H_2O)(Pa/760)(298/Ta)))-b]$$

where:

Q_{std} = actual flow rate as indicated by the calibration orifice, m³/min

H_2O = orifice manometer reading during calibration, in. H₂O

T_a = ambient temperature during calibration, K (K = 273 + °C)

298 = standard temperature, a constant that never changes, K

P_a = ambient barometric pressure during calibration, mm Hg

760 = standard barometric pressure, a constant that never changes, mm Hg

m = *Q*standard slope of orifice calibration relationship

b = *Q*standard intercept of orifice calibration relationship.

Note that the ambient temperature is needed in degrees Kelvin to satisfy the Q_{std} equation. Also, the barometric pressure needs to be reported in millimeters of mercury and it has to be at the site pressure.

The following conversions may be needed:

$$2. \quad \text{degrees Kelvin} = [5/9 (\text{degrees Fahrenheit} - 32)] + 273 \text{ or} \\ \text{degrees Kelvin} = \text{degrees Celcius} + 273$$

$$3. \quad \text{millimeters of mercury} = \text{inches of Hg} * 25.4$$

Inserting the numbers from the calibration worksheet run point number one we get:

$$4. \quad Q_{std} = 1/1.47574[(\text{Sqrt}((7.25)(749.3/760)(298/293.2)))] - (-.00613)] \\ 5. \quad Q_{std} = .6776261[(\text{Sqrt}((7.25)(.985921)(1.016371)))] + .00613] \\ 6. \quad Q_{std} = .6776261[(\text{Sqrt}(7.2649459))] + .00613] \\ 7. \quad Q_{std} = .6776261[2.6953563 + .00613] \\ 8. \quad Q_{std} = .6776261[2.7014863]$$

9. $Q_{std} = 1.831$

Throughout these example problems you may find that your answers vary some from those arrived at here. This is probably due to different calculators carrying numbers to different decimal points. The variations are usually slight and should not be a point of concern.

With the Q_{std} determined, the corrected chart reading (IC) for this run point needs to be calculated using the following equation:

10. $IC = I[\text{Sqrt}((Pa/760)(298/Ta))]$

where:

IC = continuous flow recorder readings corrected to standard

I = continuous flow recorder readings during calibration

Pa = ambient barometric pressure during calibration, mm Hg.

760 = standard barometric pressure, mm Hg

Ta = ambient temperature during calibration, K (K = 273 + °C)

298 = standard temperature, K.

Inserting the data from run point one on the calibration worksheet we get:

11. $IC = 52[\text{Sqrt}(749.3/760)(298/293.2)]$

12. $IC = 52[\text{Sqrt}(1.0020615)]$

13. $IC = 52[1.0010302]$

14. $IC = 52.05357$

This procedure should be completed for all five run points. EPA guidelines state that at least three of the five Q_{std} flow rates during the calibration be within or nearly within the acceptable operating limits of 1.10 to 1.70 m³/min (39 to 60 CFM). If this condition is not met, the instrument should be recalibrated.

Using Q_{std} as our x-axis, and IC as our y-axis, a slope, intercept, and correlation coefficient can be determined using the least squares regression method.

The equations for determining the slope (m) and intercept (b) are as follows:

$$15. \quad m = \frac{\sum xy - \frac{(\sum x)(\sum y)}{n}}{\sum x^2 - \frac{(\sum x)^2}{n}} \quad ; \quad b = \bar{y} - m\bar{x}$$

where:

n = number of observations

$\bar{y} = \Sigma y/n$; $\bar{x} = \Sigma x/n$

Σ = sum of

The equation for the coefficient of correlation (r) is as follows:

$$16. \quad r = \frac{\sum xy - \frac{(\sum x)(\sum y)}{n}}{\sqrt{\left[\sum x^2 - \frac{(\sum x)^2}{n} \right] \left[\sum y^2 - \frac{(\sum y)^2}{n} \right]}}$$

where:

n = number of observations

Σ = sum of

Before these can be determined, some preliminary algebra is necessary. Σx , Σy , Σx^2 , Σxy , $(\Sigma x)^2$, $(\Sigma y)^2$, n, \bar{y} , and \bar{x} need to be determined.

17. $\Sigma x = 1.831 + 1.631 + 1.451 + 1.264 + 1.119 = 7.296$
18. $\Sigma y = 52.06 + 47.05 + 42.05 + 37.04 + 33.04 = 211.24$
19. $\Sigma x^2 = (1.831)^2 + (1.631)^2 + (1.451)^2 + (1.264)^2 + (1.119)^2 = 10.96798$
20. $\Sigma y^2 = (52.06)^2 + (47.05)^2 + (42.05)^2 + (37.04)^2 + (33.04)^2 = 9155.7518$
21. $\Sigma xy = (1.831)(52.06) + (1.631)(47.05) + (1.451)(42.05) + (1.264)(37.04) + (1.119)(33.04) = 316.865528$
22. $n = 5$
23. $\bar{x} = \Sigma x/n = 1.4592$
24. $\bar{y} = \Sigma y/n = 42.248$
25. $(\Sigma x)^2 = (7.296)^2 = 53.231616$
26. $(\Sigma y)^2 = (211.24)^2 = 44622.337$

Inserting the numbers:

27.

$$\text{slope} = \frac{316.865528 - \frac{(6.9727.296)(211.24)}{5}}{10.96798 - \frac{53.231616}{5}}$$

$$28. \quad \text{slope} = \frac{316.865528 - \frac{(1541.207)}{5}}{10.96798 - \frac{53.231616}{5}}$$

$$29. \quad \text{slope} = \frac{316.865528 - 308.2414}{10.96798 - 10.646323}$$

$$30. \quad \text{slope} = \frac{8.62412}{0.321657}$$

$$31. \quad \text{slope} = 26.811541$$

$$32. \quad \text{intercept} = 42.248 - (26.811541)(1.4592)$$

$$33. \quad \text{intercept} = 42.248 - 39.1234$$

$$34. \quad \text{intercept} = 3.1246$$

$$35. \quad \text{correlation coeff.} = \frac{(7.296)(211.24)}{316.865528 - \frac{53.231616}{5}} \sqrt{\left[\left(10.96798 - \frac{53.231616}{5} \right) \left(9155.7518 - \frac{44622.337}{5} \right) \right]}$$

$$36. \quad \text{correlation coeff.} = \frac{(1541.207)}{316.865528 - \frac{53.231616}{5}} \sqrt{[(10.96798 - 10.646323)][(9155.7518 - 8924.4674)]}$$

$$37. \quad \text{correlation coeff.} = \frac{(316.865528 - 308.2414)}{\sqrt{[(10.96798 - 10.646323)][(9155.7518 - 8924.4674)]}}$$

$$38. \text{ correlation coeff.} = \frac{8.62412}{\sqrt{(0.321657)(231.2844)}}$$

$$39. \text{ correlation coeff.} = \frac{8.62412}{\sqrt{74.394246}}$$

$$40. \text{ correlation coeff.} = \frac{8.62412}{8.6252099}$$

$$41. \text{ correlation coeff.} = .9998$$

A calibration that has a correlation coefficient of less than .990 is not considered linear and should be re-calibrated. As you can see from the worksheet we have 5 Qstd numbers that are in the TSP range (1.1 - 1.7) and the correlation coeff. is > .990 thus, we have a good calibration.

Total Volume

TE-5000 TSP Sampler with TE-5009 Continuous Flow Recorder

TE-5000 MFC TSP with TE-5009 Continuous Flow Recorder

To figure out the total volume of air that flowed through the sampler during your sampling run take a set-up reading (when you set the sampler up manually turn it on and take a continuous flow recorder reading; in our example it should be 38) and a pick-up reading (after the sample has been taken again manually turn sampler on and take a continuous recorder reading; for our example let's say it read 34). Take $38 + 34 = 72$ $72/2 = 36$ so the continuous recorder reading you would use is 36. Put that into the formula (on bottom of worksheet):

$$1/m((I)[\text{Sqrt}(298/T_{\text{av}})(P_{\text{av}}/760)] - b)$$

m = sampler slope

b = sampler intercept

I = average chart response

T_{av} = daily average temperature

P_{av} = daily average pressure

Sqrt = square root

Example:

$$\text{m}^3/\text{min} = 1/26.8212((36)[\text{Sqrt}(298/291.5)(746.8/760)] - (+3.1104))$$

$$\text{m}^3/\text{min} = .0372839 ((36)[\text{Sqrt}(1.0222984)(0.9826315)] - 3.1104)$$

$$\text{m}^3/\text{min} = .0372839 ((36)[\text{Sqrt}(1.0045426)] - 3.1104)$$

$$\text{m}^3/\text{min} = .0372839 ((36)[1.0022687] - 3.1104)$$

$$\text{m}^3/\text{min} = .0372839 ((36.081673) - 3.1104)$$

$$\text{m}^3/\text{min} = .0372839 (32.971273)$$

$$\text{m}^3/\text{min} = 1.2292976$$

$$\text{ft}^3/\text{min} = 1.2292976 \times 35.31 = 43.406498$$

$$\text{Total ft}^3 = \text{ft}^3/\text{min} \times 60 \times \text{hours that sampler ran}$$

Let's say our sampler ran 24 hours (end ETI reading - start ETI reading)

** Make sure ETI is in hours otherwise convert to hours **

$$\text{Total ft}^3 = 43.406498 \times 60 \times 24 = 62,505.355 \text{ ft}^3$$

$$\text{Total m}^3 = 1.2292976 \times 60 \times 24 = 1770.1885 \text{ m}^3$$

Sampler Operation

1. After performing calibration procedure, remove filter holder frame by loosening the four wing nuts allowing the brass bolts and washers to swing down out of the way. Shift frame to one side and remove.
2. Carefully center a new filter, rougher side up, on the supporting screen. Properly align the filter on the screen so that when the frame is in position the gasket will form an airtight seal on the outer edges of the filter.
3. Secure the filter with the frame, brass bolts, and washers with sufficient pressure to avoid air leakage at the edges (make sure that the plastic washers are on top of the frame).
4. Wipe any dirt accumulation from around the filter holder with a clean cloth.
5. Close shelter lid carefully and secure with the "S" hook.
6. Make sure all cords are plugged into their appropriate receptacles and the rubber tubing between the blower motor pressure tap and the TE-5009 continuous flow recorder is connected (be careful not to pinch tubing when closing door).
7. Prepare TE-5009 continuous flow recorder as follows:
 - a. Clean any excess ink and moisture on the inside of recorder by wiping with a clean cloth.
 - b. Depress pen arm lifter to raise pen point and carefully insert a fresh chart.
 - c. Carefully align the tab of the chart to the drive hub of the recorder and press gently with thumb to lower chart center onto hub. Make sure chart is placed under the chart guide clip and the time index clip so it will rotate freely without binding. Set time by rotating the drive hub clock-wise until the correct time on chart is aligned with time index pointer.
 - d. Make sure the TE-160 pen point rests on the chart with sufficient pressure to make a visible trace.

8. Prepare the Timer as instructed below.

9. At the end of the sampling period, remove the frame to expose the filter. Carefully remove the exposed filter from the supporting screen by holding it gently at the ends (not at the corners). Fold the filter lengthwise so that sample touches sample.

10. It is always a good idea to contact the lab you are dealing with to see how they may suggest you collect the filter and any other information that they may need.

Timer Preparation

TE-303 Digital Timer



Setting the Date and Time:

1. Press “F3” for SETUP
2. Scroll down to configure, Press “ENT”
3. Select “DATE,” insert date, press “ENT”
4. Select “TIME,” insert time (HHMM), press “ENT”
5. Press “ESC” to return to main status screen

Setting the Timer:

1. Press F1 for TIMER
2. Select “DATE,” insert start date, press “ENT”
3. Select “TIME,” insert start time (HHMM), press “ENT”
4. Select “DURATION,” insert desired duration, (0003 = 3 minutes, 0030 = 30 minutes, 0300 = 3 hours, 3000 = 30 hours)
5. Select repeat, select detailed repeat interval, (1 in 1 = sample every day, 1 in 2 = sample every other day, 1 in 3 = sample every 3 days, 1 in 6 = sample every 6 days, 1 in 7 = sample every 7 day, or custom sampling schedules (HHMM)), press “ENT”
6. SELECT “Save and Exit”
7. During a sample the timer can be “STOPPED” or “PAUSED,” during a sampled press “F1” for timer, select “PAUSE” or “ABORT,” select “YES” or “NO” to confirm

The TE-303 digital timer has an internal battery backup so in case of a power

failure the timer will remain set and will continue when power is reapplied. During a power failure the timer will continue to run and will stop and start exactly as it is programmed (for example, if the timer is scheduled to start at 9:00 and run for 24 hours, it will stop exactly 24 hours from the start-time regardless of a power failure).

Checking/Resetting the Elapsed Time Indicators (ETI):

The TE-303 has 3 built in ETI's; one ETI is to track motor life, one for calibration frequency, and one for user based events. The ETI's can be reset at any time and also have a feature that allows the user set alert reminders for tracking motor life, calibration frequency or user based event.

1. Press "F3" for set-up
2. Select "ETI" and press "ENT"
3. To reset ETI's, select desired ETI, press "ENT," confirm "YES" or "NO," and press "ENT"
4. To Set "ALERT," select desired ETI ALERT, press "ENT," enter alert, set point, press "ENT"
5. Press "ESC" to return to the main status screen

Manual Motor Control:

The TE-303 digital timer is equipped with a manual motor control feature. This feature allows the user to turn the motor (or whatever is plugged into the AC out timed cord) to be turned on/off without using the timer.

1. Press "F3" for SETUP
2. Select "DIAGNOSTICS," press "ENT"
3. Select "MOTOR," press "ENT" to toggle the motor on/off
4. Be sure that the "MOTOR" is in the OFF position before exiting this menu
5. Press "ESC" to return to the main status screen

Please visit www.tisch-env.com for a complete TE-303 Digital Timer manual.

Troubleshooting

note: this is a general troubleshooting guide, not all problem may apply to every sampler

<u>Problem</u>	<u>Solution</u>
Brush Motor Won't Turn On	<ul style="list-style-type: none"> -Check Motor brushes(Change every 500 hours) -Check Motor(Should be replaced after 2 brush changes about 1500 hours) -Check power supply -Ensure that all electrical connections are secure -Make sure timer is on -Make sure flow controller(if applicable) is adjusted properly -Check for loose or damaged wires
Brushless Motor Won't Turn On	<ul style="list-style-type: none"> -Ensure that all electrical connections are secure -Make sure flow controller(if applicable) is adjusted properly -Check power supply -Make sure timer is on -Check for loose or damaged wires
Mechanical timer not working	<ul style="list-style-type: none"> -Make sure trippers are set properly -Make sure that trippers are not pressed against switch at start up, the timer need to rotate a few degrees before the trippers hit the switch -Check for loose or damages wires -Check power supply -Check electrical hook up diagram to ensure correct installation -Check Motor
Digital timer not working	<ul style="list-style-type: none"> -Check timer settings -Make sure current date and time are correct -Make sure power cords are properly connected -Check fuse on main PC board (F3) -Check Power Supply -Check Motor

Mass Flow Controller not working	<ul style="list-style-type: none"> -Make sure timer is on -Check Motor/Motor brushes -Make sure 8 amp breaker is not popped -Make sure flow probe is installed correctly -Check all electrical connections -Check power supply
Elapsed Time Indicator not working	<ul style="list-style-type: none"> -Check Power Supply -Check electrical connections
Voltage Variator with ETI not working	<ul style="list-style-type: none"> -Check Power Supply -Check Electrical Connections -Check Motor
Flow Rate Too Low	<ul style="list-style-type: none"> -Check for leaks -Check filter media placement -Ensure only one piece of filter paper is installed -Check Flow Controller -Check flow valve(TE-1000PUF samplers only) -Ensure proper voltage is being supplied -Check calibration
Chart Recorder not working	<ul style="list-style-type: none"> -Replace pen point -Make sure pen point is touching chart -Make sure pen point is on "0" -Make sure tubing from motor is in place -Check Power Supply -Check motor
Air Leaks	<ul style="list-style-type: none"> -Make sure all gaskets are in place -Make sure all connections are secure -Makes sure connections are not over tightened -Check for damaged components: Filter holder screen, gaskets, motor flanges

Maintenance and Care

A regular maintenance schedule will allow a monitoring network to operate for longer periods of time without system failure. Our customers may find that the adjustments in routine maintenance frequencies are necessary due to the operational demands on their sampler(s). We recommend that the following cleaning and maintenance activities be observed until a stable operating history of the sampler has been established.

1. Make sure all gaskets (including motor cushion) are in good shape and that they seal properly.
2. The power cords should be checked for good connections and for cracks (replace if necessary).

CAUTION: DO NOT allow power cord or outlets to be immersed in water!

3. Inspect the filter screen and remove any foreign deposits.
4. Inspect the filter holder frame gasket each sample period and make sure of an airtight seal.
5. Check or replace motor brushes every 400 to 500 running hours.
6. Make sure continuous flow recorder pen is still inking each time, tubing has no crimps or cracks, and that the door is sealed completely.

Motor Brush Replacement

110 volt (Brush part #TE-33384)

220 volt (Brush part #TE-33378)

CAUTION: Unplug the unit from any line voltage sources before performing any service on blower motor assembly or any electrical device on this system.

The following steps are accompanied by pictures to aid your understanding of motor brush replacement procedures. **Please be aware that the pictures are standardized and may not match the equipment that you are using.** Motor brush removal and replacement does not change based on motor or brush type, so do not be confused if your equipment differs from what is pictured.

1. Remove the blower motor from the filter holder. Place on work bench. Remove the flange by removing the four bolts. This will expose the gasket and the motor.
2. Turn assembly on side, loosen the cord retainer and then push cord into housing and at the same time let motor slide out exposing the brushes.
3. Looking down at motor. There are 2 brushes, one on each side. Carefully pry the brass quick disconnect tabs (the tabs are pushed into end of brush) away from the expended brushes and toward the armature. Try to pry the tabs as far as you can without damaging the armature.
4. With a screwdriver loosen and remove brush holder clamps and release brushes. Carefully, pull quick disconnect tabs from expended brushes.



5. Carefully slide quick disconnect tabs into tab slot of new brush.



6. Push brush carbon against armature until brush housing falls into brush slot on motor.



7. Put brush holder clamps back onto brushes.
8. Make sure quick disconnect tabs are firmly seated into tab slot. Check field wires for good connections.

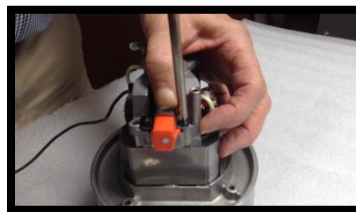

9. Assemble motor after brush replacement by placing housing over and down on the motor (at same time pull power cord out of housing), being careful not to pinch any motor wires beneath the motor spacer ring.
10. Secure power cord with the cord retainer cap.

11. Replace blower motor flange on top of motor making sure to center gasket. Assemble together with filter holder. Lower filter holder and blower motor down through top support pan on shelter.

****IMPORTANT**** To enhance motor life:

- Change brushes before brush shunt touches armature.
- Seat new brushes by applying 50% voltage for 10 to 15 minutes, the TE-5075 brush break in device allows for the 50% voltage.



TE-116311
110v MFC Motor



TE-33384
110v MFC Motor Brush (Green)



TE-116312
220v MFC Motor



TE-33378
220v MFC Motor Brush (Brown)

Warranty

Instruments manufactured by Tisch Environmental, Inc. are guaranteed by warranty to be free of defects in materials and workmanship for one year after shipment from Tisch Environmental factories. The liability of Tisch Environmental, Inc. is limited to servicing or replacing any defective part of any instrument returned to the factory by the original purchaser. All service traceable to defects in original material or workmanship is considered warranty service and is performed free of charge. The expense of warranty shipping charges to and from our factory will be borne by Tisch Environmental. Service performed to rectify an instrument malfunction caused by abuse, acts of god or neglect, and service performed after the one-year warranty period will be charged to the customer at the current prices for labor, parts, and transportation. Brush-type and brushless motors will carry a warranty as far as the original manufacture will pass through its warranty to Tisch Environmental, Inc. The right is reserved to make changes in construction, design specifications, and prices without prior notice.

Assembly Drawings

TE-5005 Blower Motor Assembly

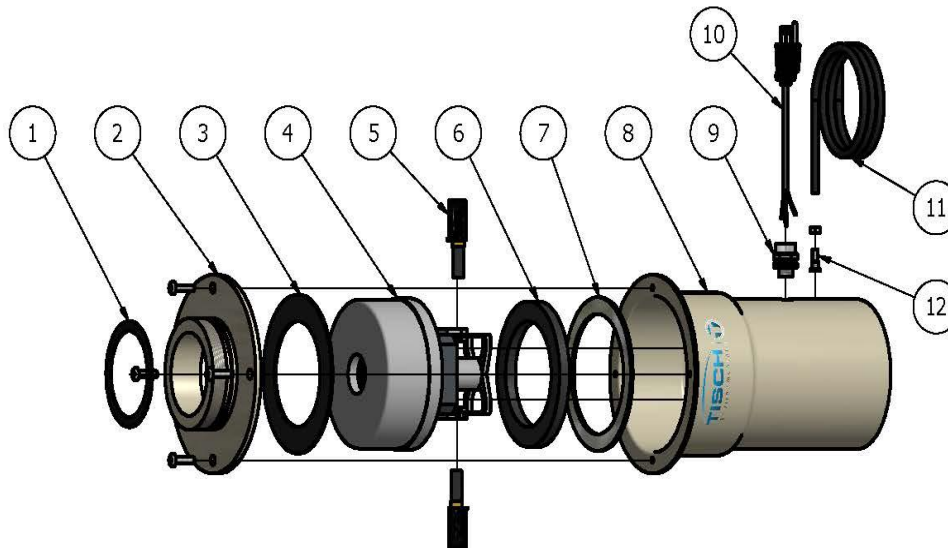

TE-5005 Brush Type Aluminum Blower Motor Assembly			
ITEM	QTY	PART NUMBER	DESCRIPTION
1	1	TE-5005-9	Filter Holder Gasket (between Filter Holder and Blower Motor)
2	1	TE-5005-1	Blower Motor Flange
3	1	TE-5005-2	Flange Gasket
4	1	TE-116311 TE-116312	Motor for 110V MFC Blower Motor for 220V MFC Blower
5	2	TE-33384 TE-33378	Motor Brushes for 110V Motor MFC Motor Brushes for 220V Motor MFC
6	1	TE-5005-4	Motor Cushion
7	1	TE-5005-5	Motor Spacer Ring
8	1	TE-5005-3	Aluminum Blower Motor Housing
9	1	TE-5005-7	Cord Retainer w/ Nut
10	1	TE-5010-4	Power Cord
11	1	TE-5005-6	Tubing 3 ft. Piece
12	1	TE-5005-8	Pressure Tap w/ Nut

TE-5003 Filter Holder Assembly

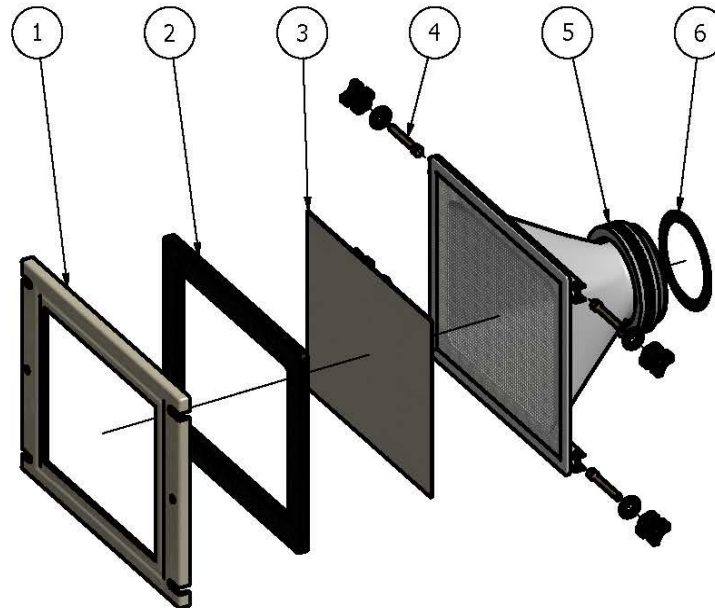

TE-5003 Filter Holder Assembly			
ITEM	QTY	PART NUMBER	DESCRIPTION
1	1	TE-3000-2	Hold Down Frame
2	1	TE-5018	8" x 10" Gasket
3	1	N/A	Filter Paper
4	4	TE-5003-9	Plastic Thumb Nut, Brass Bolt, Washer, and Rivet
5	1	TE-5028-9	Aluminum Threaded Ring
6	1	TE-5005-9	Filter Holder Gasket (Between Filter Holder and Blower Motor)

Calibration Worksheet



TE-5000 TSP Sampler Calibration (Dickson Recorder)

Site Information

Location: Cleves, Ohio	Site ID: 145	Date: 31-Oct-14
Sampler: TE-5000 TSP	Serial No: 467	Tech: Jim Tisch

Site Conditions

Barometric Pressure (in Hg): 29.50	Corrected Pressure (mm Hg): 749.3
Temperature (deg F): 68.0	Temperature (deg K): 293.2
Average Press. (in Hg): 29.40	Corrected Average (mm Hg): 746.8
Average Temp (Deg F): 65.0	Average Temp: (Deg K): 291.5

Calibration Orifice

Make: Tisch	Qstd Slope: 1.47574
Model: TE-5028A	Qstd Intercept: -0.00613
Serial#: 2978	Calibration Due Date 24-Oct-15

Calibration Information

Plate or Test #	H2O (in)	Qstd (m3/min)	I (chart)	IC (corrected)	Linear Regression
1	7.25	1.831	52.0	52.06	Slope: 26.8212 Intercept: 3.1104 Corr. Coeff: 0.9998
2	5.75	1.631	47.0	47.05	
3	4.55	1.451	42.0	42.05	
4	3.45	1.264	37.0	37.04	
5	2.70	1.119	33.0	33.04	
					# of Observations: 5

Calculations

$$Qstd = 1/m[\text{Sqrt}(H2O(Pa/Pstd)(Tstd/Ta))-b]$$

$$IC = I[\text{Sqrt}(Pa/Pstd)(Tstd/Ta)]$$

Qstd = standard flow rate
 IC = corrected chart response
 I = actual chart response
 m = calibrator Qstd slope
 b = calibrator Qstd intercept
 Ta = actual temperature during calibration (deg K)
 Pa = actual pressure during calibration (mm Hg)
 Tstd = 298 deg K
 Pstd = 760 mm Hg
 For subsequent calculation of sampler flow:
 $1/m((I)[\text{Sqrt}(298/Tav)(Pav/760)]-b)$

m = sampler slope
 b = sampler intercept
 I = chart response
 Tav = daily average temperature
 Pav = daily average pressure

Enter Average I (chart):	36.0
Average Flow Calculation m3/min	1.229301266
Average Flow Calculation in cfm	43.40753001
Sample Time (Hrs):	24.0
Total flow in 24 hours m3/min	1770.193823
Total flow in 24 hours cfm	62506.84321

NOTE: Ensure calibration orifice has been certified within 12 months of use

Calibrator Certificate



TISCH ENVIRONMENTAL, INC.
 145 SOUTH MIAMI AVE
 VILLAGE OF CLEVELAND, OH
 45002
 513.467.9000
 877.263.7610 TOLL FREE
 513.467.9009 FAX

ORIFICE TRANSFER STANDARD CERTIFICATION WORKSHEET TE-5028A

Date - Oct 24, 2014 Roots-meter S/N 9833620 Ta (K) - 296
 Operator Tisch Orifice I.D. - 2978 Pa (mm) - 755.65

PLATE OR VDC #	VOLUME START (m3)	VOLUME STOP (m3)	DIFF VOLUME (m3)	DIFF TIME (min)	METER	ORFICE
					DIFF Hg (mm)	DIFF H2O (in.)
1	NA	NA	1.00	1.1880	4.5	1.50
2	NA	NA	1.00	0.9230	7.5	2.50
3	NA	NA	1.00	0.8380	9.0	3.00
4	NA	NA	1.00	0.7790	10.5	3.50
5	NA	NA	1.00	0.5860	18.0	6.00

DATA TABULATION

Vstd	(x axis) Qstd	(y axis)	Va	(x axis) Qa	(y axis)
0.9950	0.8375	1.2254	0.9940	0.8367	0.7665
0.9910	1.0737	1.5819	0.9901	1.0727	0.9896
0.9891	1.1803	1.7329	0.9881	1.1791	1.0840
0.9871	1.2671	1.8718	0.9861	1.2659	1.1709
0.9771	1.6674	2.4507	0.9761	1.6657	1.5331
Qstd slope (m) = 1.47574			Qa slope (m) = 0.92408		
intercept (b) = -0.00613			intercept (b) = -0.00383		
coefficient (r) = 0.99985			coefficient (r) = 0.99985		
y axis = SQRT[H2O(Pa/760) (298/Ta)]			y axis = SQRT[H2O(Ta/Pa)]		

CALCULATIONS

$$Vstd = \text{Diff. Vol} [(Pa - \text{Diff. Hg}) / 760] (298 / Ta)$$

$$Qstd = Vstd / \text{Time}$$

$$Va = \text{Diff Vol} [(Pa - \text{Diff Hg}) / Pa]$$

$$Qa = Va / \text{Time}$$

For subsequent flow rate calculations:

$$Qstd = 1/m \{ [\text{SQRT} (H2O (Pa/760) (298/Ta))] - b \}$$

$$Qa = 1/m \{ [\text{SQRT} H2O (Ta/Pa)] - b \}$$